



General Land Use Application

1 page

Consultant: AKS Engineering & Forestry, LLC
Attn: Chris Goodell- chrisg@aks-eng.com
12965 SW Herman Road, Suite 100
Tualatin, OR 97062

Name of Project:	Type II Variance- Lot 9 Hood River Heights Subdivision
Location or Address:	

Map & Tax Lot #	T: 25E	R: 19	Section:	Tax Lot (s): 500
----------------------------	---------------	--------------	-----------------	----------------------------

Request: Type II variance application for a future home site within the Hood View Heights Subdivision.
Attached narrative provides a greater description of request.

I am the (check one) owner lessee of the property listed above, and the statements and information contained herein are in all respects true, complete and correct to the best of my knowledge and belief.

Applicant (if different than owner) The Holt Group, Inc.	Owner Holt Holdings OR, LLC
Address PO Box 61426	Address 1300 Esther Street, Second Floor
City/State/Zip Vancouver, WA 98666	City/State/Zip Vancouver, WA 98660
Email Contact Consultant	Email Contact Consultant
Phone Contact Consultant	Phone Contact Consultant
Signature 	Signature

Staff Use Only

File #: 23-043 VAR	Date:	Fee\$:	Planner: P. Depa
Type of review:	Type I <input type="checkbox"/>	Type II <input checked="" type="checkbox"/>	Type III <input type="checkbox"/> Type IV <input type="checkbox"/>
Has applicant attended a pre-app?	Yes <input type="checkbox"/>	No <input type="checkbox"/>	If yes, date of pre-app meeting:

Hood View Heights Subdivision Lot 9 Variance Application

Date: October 2023

Submitted to: City of Sandy
Planning Division
39250 Pioneer Boulevard
Sandy, OR 97055

Applicant: The Holt Group, Inc.
PO Box 61426
Vancouver, WA 98666

AKS Job Number: 10273-01



AKS
ENGINEERING & FORESTRY

12965 SW Herman Road, Suite 100
Tualatin, OR 97062
(503) 563-6151

Table of Contents

I.	Executive Summary	2
II.	Site Description/Setting	2
III.	Applicable Review Criteria	2
	CITY OF SANDY DEVELOPMENT CODE	2
	CHAPTER 17.34 - SINGLE-FAMILY RESIDENTIAL (SFR).....	2
	CHAPTER 17.66 - ADJUSTMENTS AND VARIANCES.....	3
IV.	Conclusion	7

Tables

Table 1: Development Standards.....	2
-------------------------------------	---

Exhibits

- Exhibit A:** Hood View Heights Final Subdivision Plat
- Exhibit B:** Cedar Creek Heights Construction Plan Sheet
- Exhibit C:** Notice of Decision (City File No. 21-012 SUB/FSH/TREE)

Hood View Heights Subdivision

Lot 9 Variance Application

Submitted to: City of Sandy
Planning Division
39250 Pioneer Boulevard
Sandy, OR 97055

Applicant: The Holt Group, Inc.
PO Box 61426
Vancouver, WA 98666

Property Owner: Holt Holdings OR, LLC
1300 Esther Street, Second Floor
Vancouver, WA 98660

Applicant's Consultant: AKS Engineering & Forestry, LLC
12965 SW Herman Road, Suite 100
Tualatin, OR 97062

Contact: Chris Goodell
Email: chrisg@aks-eng.com
Phone: (503) 563-6151

Site Location: Northeast of Hwy 26; west of the southeastern end of Vista Loop Drive; within the city of Sandy, OR.

Clackamas County Assessor's Map: 25E19; Tax Lot 500 (Parent Property)

Site Size: Hood View Heights Lot 9: ±8,158 sq. ft.

Land Use District: Single-Family Residential (SFR)

I. Executive Summary

The Hood View Heights application (aka Cedar Creek Heights) included two separate phases. Hood View Heights, in general, which includes Lot 9 is considered to be Phase 1. As detailed herein, the parent parcel for Hood View Heights was subject to a variety of constraints, a few of which include its location (fronting on Hwy 26 and Vista Loop Drive), the narrow/triangular shape of the property, and the steep topography along Hwy 26. At the time the subdivision application was being prepared and processed, it was understood by the applicant that variances to certain development standards would likely be desired to build homes on several of the lots. However, at the time it was decided to defer variance applications to the home design/building stage, a more appropriate point in the process.

The Holt Group, Inc. (Applicant) is submitting this application for a Type II Variance to accommodate a future home on Lot 9 of the Hood View Heights Subdivision (Exhibit A) that was approved by the City of Sandy on June 15, 2021, (File no. 21-012 SUB/FSH/TREE) (Exhibit C). Hence, this application involves two variances for the future home on Lot 9. The first variance would adjust the 20-foot transit street setback to 10 feet, which is the minimum side yard setback for a property abutting a street in the Single-Family Residential District. The second variance involves the building orientation standards for properties adjacent to transit streets. For purposes of this review, Hwy 26 is the transit street from which variances are applicable. The variances and relevant criteria are described in greater detail in Sec. 17.66.60. below.

This application includes the City application forms, written materials, and preliminary plans necessary for City staff to review and determine compliance with the applicable approval criteria. The evidence is substantial and supports the City’s approval of the application.

II. Site Description/Setting

The subject property (Lot 9) has an address of 18670 Warm Springs Street, Sandy, OR 97055, and comprises a total area of ±8,158 sq. ft. The property is zoned Single Family Residential (SFR) and is located immediately northeast of Hwy 26 and southwest of Vista Loop Drive, within the City of Sandy.

III. Applicable Review Criteria

CITY OF SANDY DEVELOPMENT CODE

CHAPTER 17.34 - SINGLE-FAMILY RESIDENTIAL (SFR)

Sec. 17.34.10. - Permitted uses.

A. Primary Uses Permitted Outright: 1. Single detached dwelling subject to design standards in Chapter 17.90;

...

Sec. 17.34.30. - Development standards.

Table 1: Development standards

Type	Predominant Zoning Designation	Standard
A. Minimum Lot Area	Single detached dwelling or duplex	7,500 square ft.
	Other permitted uses	No minimum
B. Minimum Average Lot Width	Single detached dwelling or duplex	60 ft.

C. Minimum Lot Frontage		20 ft.
D. Minimum Average Lot Depth	No minimum	10 ft. minimum
E. Setbacks (Main Building)	Front yard	10 ft. minimum
	Rear yard	20 ft. minimum
	Side yard (interior)	7.5 ft. minimum
	Corner lot	10 ft. minimum on side abutting street ¹
F. Setbacks (Garage/Carport)		22 ft. minimum for front vehicle access 15 ft. minimum if entrance is perpendicular to street 5 ft. minimum for alley or rear access
G. Projections into Required Setbacks		See Chapter 17.74
H. Accessory Structures in Required Setbacks		See Chapter 17.74
I. Structure Height		35 ft. maximum
J. Building Site Coverage		No minimum
K. Off-Street Parking		See Chapter 17.98

Response: The applicant does not request a variance to the standards of Sec. 17.34.30. These standards will be met.

CHAPTER 17.66 - ADJUSTMENTS AND VARIANCES

Sec. 17.66.60. Variances.

Variances are a means of requesting a complete waiver or major adjustment to certain development standards. They may be requested for a specific lot or as part of a land division application. The Type II variance process is generally reserved for major adjustments on individual lots, while variances to development standards proposed as part of a land division are processed as a Type III application (requiring a public hearing).

Response: For clarification purposes, unlike a number of other lots within the subdivision and as addressed in the staff report (File no. 21-012 SUB/FSH/TREE), Sandy Development Code Sec. 17.74.40(A)(7) is not applicable to Lot 9. Sec. 17.74.40(A)(7) requires; *“Fences on Through Lots. Gates are required in rear-yard fences on through-lots since it remains the property owners’ responsibility to maintain the area from the curb or edge of pavement to a proposed fence.”* Sec. 17.10.030 defines a through lot as a lot of record whose front and rear lot lines both abut streets. The property line abutting Hwy 26 is a side lot line, and any fence would be considered a side-yard fence. Therefore, a gate is not required and a variance to this standard is not necessary for Lot 9.

The application involves two variances for Lot 9 of the approved and recorded Hood View Heights Subdivision, as outlined below.

¹ Shall comply with clear vision requirements of Chapter 17.74.

Variance #1: Sandy Development Code Sec. 17.80.20 requires; *“any structure located on streets listed above or identified in the Transportation System Plan as arterials or collectors shall have a minimum setback of 20 feet measured from the property line. This applies to applicable front, rear and side yards.”*

This application includes a variance to the 20-foot minimum setback for the side yard adjacent to Hwy 26, a major arterial. Instead, a 10-foot setback is planned, which is the minimum side yard setback for a property abutting a street in the Single-Family Residential District. This variance is necessary to address atypical site conditions, including lot orientation and the resultant building envelope, that significantly limit the area available for a new home and is discussed in greater detail below.

Variance #2: This application also includes a variance to the building orientation standards of Section 17.82.20(A)-(C). These standards are cited below. Subsection D is not applicable because the subject site does not have frontage on more than one transit street.

- A. All residential dwellings shall have their primary entrances oriented toward a transit street rather than a parking area, or if not adjacent to a transit street, toward a public right-of-way or private walkway which leads to a transit street.*
- B. Dwellings shall have a primary entrance connecting directly between the street and building interior. A clearly marked, convenient, safe and lighted pedestrian route shall be provided to the entrance, from the transit street. The pedestrian route shall consist of materials such as concrete, asphalt, stone, brick, permeable pavers, or other materials as approved by the Director. The pedestrian path shall be permanently affixed to the ground with gravel subsurface or a comparable subsurface as approved by the Director.*
- C. Primary dwelling entrances shall be architecturally emphasized and visible from the street and shall include a covered porch at least 5 feet in depth.*
- D. If the site has frontage on more than one transit street, the dwelling shall provide one main entrance oriented to a transit street or to a corner where two transit streets intersect.*

Lot 9 has been assigned an address of 18670 Warm Springs Street and will take access from Warm Springs Street. Due to site characteristics e.g., location, lot orientation and topography between Lot 9 and Hwy 26, the designated transit street, useable area is restricted, and the space/functional use of the site is compromised. If the applicant were to meet the requirements in (A)-(C), the site would be designed and the dwelling oriented towards a significant downslope (40-50%) down to Hwy 26, which is also highway right-of-way (Exhibit B). The combination of topographic relief and the speed of travel on Hwy 26 do not provide safe pedestrian transit options, thus rendering the residential dwelling orientation standards ineffective. For these reasons, the future building elevation facing Warm Springs Street will provide as the primary entrance for the dwelling.

Sec. 17.66.70. Type II and type III variance criteria.

The authority to grant a variance does not include authority to approve a development that is designed, arranged or intended for a use not otherwise approvable in the location. The criteria are as follows:

- A. The circumstances necessitating the variance are not of the applicant's making.**

Response:

Variance #1: The circumstances necessitating the variances, including transit street setbacks, are not of the applicant's making. The site geometry of the parent property's frontage on both on Vista Loop Drive (collector) and Hwy 26 (arterial) constrained the subdivision design. Despite meeting the applicable dimensional requirements for the SFR District, Lot 9 has a side yard adjacent to Hwy 26 (Exhibit A). This makes it extremely challenging to conform to the 20-foot transit street setback without compromising the functional use and design of the future home. The variance is necessary to allow for a more efficient and practical design that maximizes the use of the available land while ensuring compliance with other applicable regulations.

Variance #2: The circumstances necessitating the variances, including building orientation, are not of the applicant's making. The site geometry of the parent property's frontage on both on Vista Loop Drive (collector) and Hwy 26 (arterial) constrained the subdivision design. Despite meeting the applicable dimensional requirements for the SFR District, Lot 9 has a side yard adjacent to Hwy 26 (Exhibit A). This makes it extremely challenging to conform to the building orientation standards without compromising the functional use and design of the future home. The variance is necessary to allow for a more efficient and practical design that maximizes the use of the available land while ensuring compliance with other applicable regulations.

- B. The hardship does not arise from a violation of this Code, and approval will not allow otherwise prohibited uses in the district in which the property is located.

Response:

Variance #1: The hardship does not arise from violation of the code. Lot 9 was created by a subdivision application that was approved by the City of Sandy. Approval of a 10-foot setback from the designated transit street (Hwy 26) will not allow an otherwise prohibited use in the SFR District.

Variance #2: The hardship does not arise from violation of the code. Lot 9 was created by a subdivision application that was approved by the City of Sandy. Modifying the building orientation to allow for the primary entrance to face and for pedestrians to take access from Warm Springs Street will not allow an otherwise prohibited use in the SFR District.

- C. Granting of the variance will not adversely affect implementation of the Comprehensive Plan.
- D. The variance authorized will not be materially detrimental to the public welfare or materially injurious to other property in the vicinity.

Response:

Variance #1: A variance to the transit street setback standard will not adversely affect implementation of the Comprehensive Plan nor will it be detrimental to the public welfare or injurious to other property in the vicinity. Lot 9 does not abut properties outside of Hood View Heights. Approval of the variance will assure that the future home can be designed and built in a manner that is commensurate with surrounding homes.

Variance #2: A variance to the building orientation standards for the future home adjacent to a transit street will not adversely affect implementation of the Comprehensive Plan nor will it be detrimental to the public welfare or injurious to other property in the vicinity. Lot 9 does not abut properties outside of

Hood View Heights. Approval of the variance will assure that the future home is appropriately sited and oriented in a similar manner to other surrounding homes in the area.

- E. The development will be the same as development permitted under this Code and City standards to the greatest extent that is reasonably possible while permitting some economic use of the land.

Response:

Variance #1: Without the approved variance, 42% of the total lot width would be considered as setback areas, thus restricting the buildable area. Allowing the variance to the 20-foot transit street setback standard will allow the applicant to construct a dwelling in compliance with the SFR zoning regulations. Approval of this variance allows for a similar size home to be built on Lot 9 (compared to the other lots in the subdivision).

Variance #2: With a variance to the building orientation standards, the applicant can construct a dwelling with a primary entrance and front door oriented towards the front yard, rather than in a side yard facing and providing access to a state highway. Approval of this variance allows for the home to not only be built in compliance with the SFR zoning regulations, but to be also built in a similar fashion as surrounding homes in the subdivision in general whose front doors will face the interior local streets.

- F. Special circumstances or conditions apply to the property which do not apply generally to other properties in the same zone or vicinity, and result from lot size or shape (legally existing prior to the effective date of this Code), topography, or other circumstances over which the applicant has no control.

Response: As described in (A)-(E) above, special circumstances and conditions apply to the subject property that necessitate approval of the two identified variances.

Variance #1: The triangular shape and narrow width (sandwiched between collector and arterial roadways) of the parent property on Vista Loop Drive (collector) and Hwy 26 (arterial) constrained the original subdivision design and resulted in significant topographic constraint between the site (Lot 9) and Hwy 26. As a result, the lot is limited in width and has a side yard adjacent to Hwy 26 which requires a 20-foot setback. This setback significantly limits the area available for a new home and compromises the functional use and design. Additionally, as described in (A) above, these constraints were not of the applicant's making and are circumstances of which the applicant has no control over other than to obtain a variance.

Variance #2: With a variance to the building orientation standards, the applicant can construct a dwelling with a primary entrance and front door oriented towards the front yard, rather than in a side yard facing and providing access to Hwy 26, a state highway with a 55-mph speed limit. Not only does the property abut a state highway, but the highway right-of-way adjacent to the property has significant topographic relief (40-50% downslope) (Exhibit B). This makes pedestrian access and utilization both impractical and unsafe. Approval of the variance to Sec. 17.82.020(A)-(C) will allow the future home to be built without compromising functional use and design, while still following the SFR zoning regulations. Also, as described in (A) above, these constraints were not of the applicant's making and are circumstances of which the applicant has no control over other than to obtain a variance.

Sec. 17.66.90. Application.

An application for an adjustment or variance shall be made on forms provided by the Director and include the following, where applicable:

-
- A. Description of the land (address, lot, block, tract, or similar description) on which the proposed development is to take place.
 - B. Narrative addressing how the application meets the specified review criteria.
 - C. Site plan no larger than 11 inches by 17 inches (include a reduced copy if drawn larger) suitable for photocopy reproduction. The site plan shall be drawn to scale and show:
 1. Relationship of the site to adjoining properties, streets, alleys, structures, public utilities, and drainageways;
 2. Lot line dimensions;
 3. Existing and proposed structures;
 4. Structures on adjacent property(ies) affected by the request;
 5. Vehicle and pedestrian access points and accessways;
 6. Drainageways and any other prominent features;
 7. Location of trees and shrubs over three feet in height;
 8. Fences and walls;
 9. Off-street parking facilities;
 10. Any other information relevant to the proposal.

The Director may modify the submission requirements as necessary.

Sec. 17.66.100. - Elevation of application type.

Prior to the decision date, the review of a Type I or II adjustment or variance, and any comments received, may cause the Director to elevate the request to a Type III Variance. In this case the Director shall notify the Applicant and any parties in writing, giving the reason(s) that the application is found to qualify as a Type III Variance, requesting any additional information required by this Chapter, and requesting any additional fees applicable under the redefined application type. Upon receipt of new application materials and payment of the revised application fee, the Director shall schedule a public hearing and serve public notice as required in this Chapter.

Response: This application is submitted and is intended for review by the City through a Type II procedure.

Sec. 17.66.190. - Effective period of approval.

Approval of an adjustment or variance shall be effective for a two-year period from the date of approval, unless substantial construction has taken place. The Director (Type I and Type II) or Planning Commission (Type III) may grant a one-year extension if the applicant requests such an extension prior to expiration of the initial time limit.

Response: The effective period of approval for this application is understood.

IV. Conclusion

The required findings have been made and this written narrative and accompanying documentation demonstrate that the application is consistent with the applicable provisions of the City of Sandy Development Code. The evidence in the record is substantial and supports approval of the application. Therefore, City staff can rely upon this information in its approval of this Variance application.

Exhibit A: Hood View Heights Final Subdivision Plat

HOOD VIEW HEIGHTS

LOCATED IN THE NW 1/4 OF THE NE 1/4 OF SECTION 19, TOWNSHIP 2 SOUTH,
RANGE 5 EAST, W.M., CITY OF SANDY, CLACKAMAS COUNTY OREGON
JULY 21, 2023 SCALE: 1" = 100'

BOOK 155 PAGE 005
PLAT NO. 4714

INDEX

- SHEET 1 INDEX, LEGEND, BOUNDARY.
- SHEET 2 LOTS 1-15, TRACT A, LEGEND, AND EASEMENTS.
- SHEET 3 LOTS 28-37, LEGEND, AND EASEMENTS.
- SHEET 4 LOTS 16-27, LEGEND, AND EASEMENTS.
- SHEET 5 SURVEY CERTIFICATE, SURVEYOR'S NARRATIVE, APPROVALS, DECLARATION, ACKNOWLEDGEMENTS

LEGEND

- ▲ 5/8" BY 30" IR W/YPC "ACS&P 503-668-3151" SET ON 9/5/2023.
- 5/8" BY 30" IR W/YPC MARKED "ACS&P 503-668-3151" SET ON 9/5/2023.
- ⊙ 5/8" BY 30" IR W/YPC MARKED "ACS&P 503-668-3151" IN MONUMENT BOX, SET ON 9/5/2023.
- ⊗ 5/8" BY 30" IR W/ALC MARKED "ACS&P 503-668-3151" SET ON 9/5/2023.
- ⊘ 1 1/2" BRASS DISK MARKED "ACS&P 503-668-3151" SET ON 9/5/2023.
- ▲ FOUND 5/8" IR W/YPC "ACS&P 668-3151", SET IN (R)10, HELD
- FOUND MONUMENT AS NOTED HEREON
- ⊗ FOUND 5/8" IR W/YPC "HULT 2427", SET IN (R)6, HELD
- ⊘ FOUND 5/8" IR W/YPC "ACS&P 503-668-3151", SET IN (R)4, HELD
- OU ORIGIN UNKNOWN
- W/ALC WITH ALUMINUM CAP, MARKED
- W/YPC INDICATES WITH YELLOW PLASTIC CAP, MARKED
- IR INDICATES IRON ROD
- IP INDICATES IRON PIPE
- PS INDICATES POINT OF SPIRAL CURVE
- PSC INDICATES POINT OF SPIRAL CURVE TO CIRCULAR CURVE
- PT INDICATES POINT OF TANGENCY
- (R)1 INDICATES SURVEY NUMBER 17888, CLACKAMAS COUNTY SURVEY RECORDS
- (R)2 INDICATES SURVEY NUMBER 20575, CLACKAMAS COUNTY SURVEY RECORDS
- (R)3 INDICATES SURVEY NUMBER 29162, CLACKAMAS COUNTY SURVEY RECORDS
- (R)4 INDICATES PARTITION PLAT NO 2021-036, CLACKAMAS COUNTY PLAT RECORDS
- (R)5 INDICATES SURVEY NUMBER 2007-357, CLACKAMAS COUNTY SURVEY RECORDS
- (R)6 INDICATES PARTITION PLAT NO 2015-064, CLACKAMAS COUNTY PLAT RECORDS
- (R)7 INDICATES SURVEY NUMBER 2005-392, CLACKAMAS COUNTY SURVEY RECORDS
- (R)8 INDICATES SURVEY NUMBER 1956-036, CLACKAMAS COUNTY SURVEY RECORDS
- (R)9 INDICATES SURVEY NUMBER 2017-027, CLACKAMAS COUNTY SURVEY RECORDS
- (R)10 INDICATES SURVEY NUMBER SN2022-190, CLACKAMAS COUNTY SURVEY RECORDS

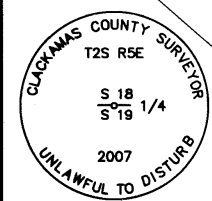
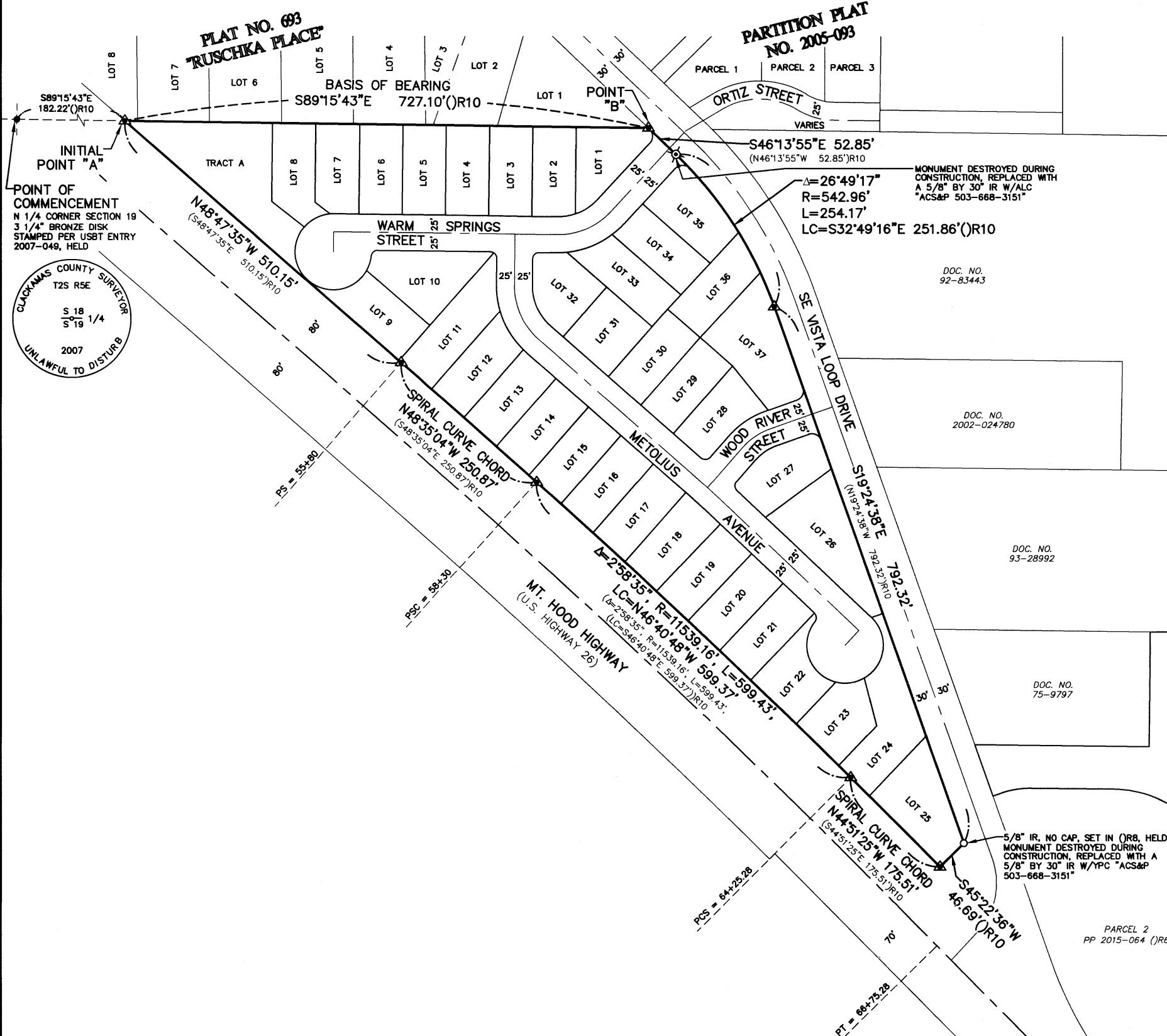
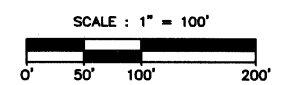

REGISTERED PROFESSIONAL LAND SURVEYOR

OREGON
JANUARY 23, 1990
DALE L. HULT
2427

RENEWS 07/01/2025

CLIENT: EVEN BETTER HOMES, INC.

All County Surveyors & Planners, Inc.
Surveying, Planning and Civil Engineering
P.O. Box 955 Sandy, OR 97055
Phone: (503) 668-3151
Fax: (503) 668-4730
Subject to General Conditions 2006 ©

DRAWN: JTD CHECKED: LKF APPROVED: DLH

DWG NUMBER: 19-071 - PLAT.dwg SHEET 1 OF 5 DATE OF PLOT: 07-21-23

HOOD VIEW HEIGHTS

LOCATED IN THE NW 1/4 OF THE NE 1/4 OF SECTION 19, TOWNSHIP 2 SOUTH,
RANGE 5 EAST, W.M., CITY OF SANDY, CLACKAMAS COUNTY OREGON
JULY 21, 2023 SCALE: 1" = 40'

BOOK 155 PAGE 005
PLAT NO. 4714

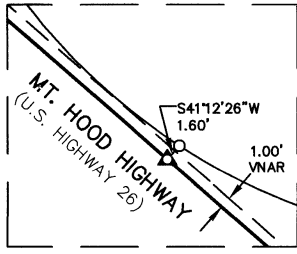
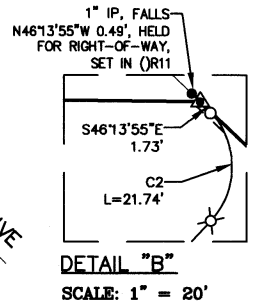
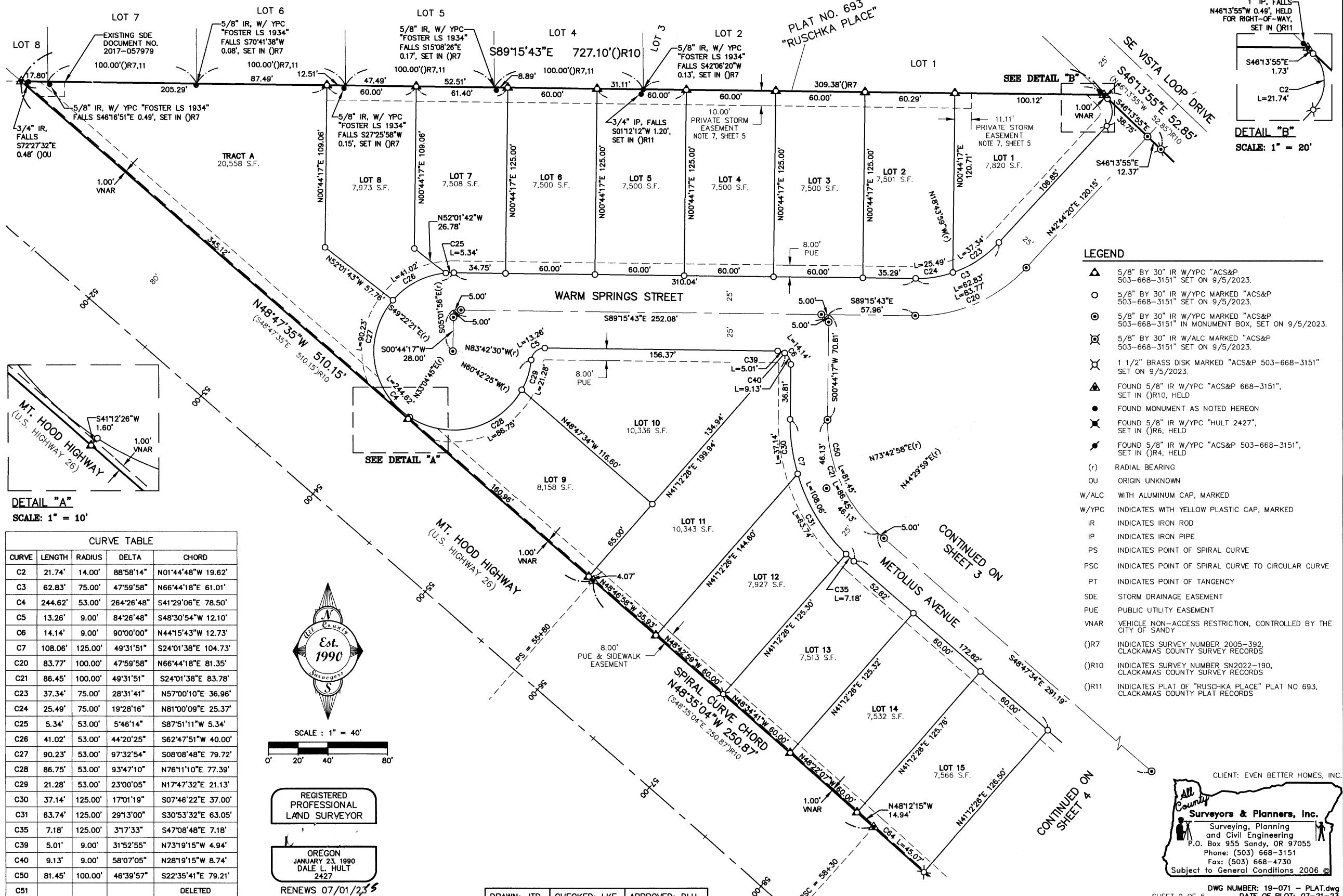

- ### LEGEND
- ▲ 5/8" BY 30" IR W/YPC "ACS&P 503-668-3151" SET ON 9/5/2023.
 - 5/8" BY 30" IR W/YPC MARKED "ACS&P 503-668-3151" SET ON 9/5/2023.
 - ⊙ 5/8" BY 30" IR W/YPC MARKED "ACS&P 503-668-3151" IN MONUMENT BOX, SET ON 9/5/2023.
 - ⊗ 5/8" BY 30" IR W/ALC MARKED "ACS&P 503-668-3151" SET ON 9/5/2023.
 - ⊘ 1 1/2" BRASS DISK MARKED "ACS&P 503-668-3151" SET ON 9/5/2023.
 - ▲ FOUND 5/8" IR W/YPC "ACS&P 668-3151", SET IN (R)10, HELD
 - FOUND MONUMENT AS NOTED HEREON
 - ⊗ FOUND 5/8" IR W/YPC "HULT 2427", SET IN (R)6, HELD
 - ⊘ FOUND 5/8" IR W/YPC "ACS&P 503-668-3151", SET IN (R)4, HELD
 - (r) RADIAL BEARING
 - OU ORIGIN UNKNOWN
 - W/ALC WITH ALUMINUM CAP, MARKED
 - W/YPC INDICATES WITH YELLOW PLASTIC CAP, MARKED
 - IR INDICATES IRON ROD
 - IP INDICATES IRON PIPE
 - PS INDICATES POINT OF SPIRAL CURVE
 - PSC INDICATES POINT OF SPIRAL CURVE TO CIRCULAR CURVE
 - PT INDICATES POINT OF TANGENCY
 - SDE STORM DRAINAGE EASEMENT
 - PUE PUBLIC UTILITY EASEMENT
 - VNAR VEHICLE NON-ACCESS RESTRICTION, CONTROLLED BY THE CITY OF SANDY
 - (R)7 INDICATES SURVEY NUMBER 2005-392, CLACKAMAS COUNTY SURVEY RECORDS
 - (R)10 INDICATES SURVEY NUMBER SN2022-190, CLACKAMAS COUNTY SURVEY RECORDS
 - (R)11 INDICATES PLAT OF "RUSCHKA PLACE" PLAT NO 693, CLACKAMAS COUNTY PLAT RECORDS

CURVE	LENGTH	RADIUS	DELTA	CHORD
C2	21.74'	14.00'	88°58'14"	N01°44'48"W 19.62'
C3	62.83'	75.00'	47°59'58"	N66°44'18"E 61.01'
C4	244.62'	53.00'	264°26'48"	S41°29'06"E 78.50'
C5	13.26'	9.00'	84°26'48"	S48°30'54"W 12.10'
C6	14.14'	9.00'	90°00'00"	N44°15'43"W 12.73'
C7	108.06'	125.00'	49°31'51"	S24°01'38"E 104.73'
C20	83.77'	100.00'	47°59'58"	N66°44'18"E 81.35'
C21	86.45'	100.00'	49°31'51"	S24°01'38"E 83.78'
C23	37.34'	75.00'	28°31'41"	N57°00'10"E 36.96'
C24	25.49'	75.00'	19°28'16"	N81°00'09"E 25.37'
C25	5.34'	53.00'	5°46'14"	S87°51'11"W 5.34'
C26	41.02'	53.00'	44°20'25"	S62°47'51"W 40.00'
C27	90.23'	53.00'	97°32'54"	S08°08'48"E 79.72'
C28	86.75'	53.00'	93°47'10"	N76°11'10"E 77.39'
C29	21.28'	53.00'	23°00'05"	N17°47'32"E 21.13'
C30	37.14'	125.00'	17°01'19"	S07°46'22"E 37.00'
C31	63.74'	125.00'	29°13'00"	S30°53'32"E 63.05'
C35	7.18'	125.00'	31°7'33"	S47°08'48"E 7.18'
C39	5.01'	9.00'	31°52'55"	N73°19'15"W 4.94'
C40	9.13'	9.00'	58°07'05"	N28°19'15"W 8.74'
C50	81.45'	100.00'	46°39'57"	S22°35'41"E 79.21'
C51				DELETED

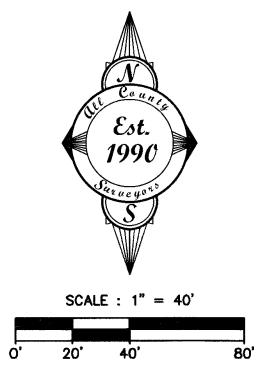

DRAWN: JTD | CHECKED: LKF | APPROVED: DLH

CLIENT: EVEN BETTER HOMES, INC.

All County Surveyors & Planners, Inc.

Surveying, Planning and Civil Engineering
P.O. Box 955 Sandy, OR 97055
Phone: (503) 668-3151
Fax: (503) 668-4730
Subject to General Conditions 2006 ©

HOOD VIEW HEIGHTS

LOCATED IN THE NW 1/4 OF THE NE 1/4 OF SECTION 19, TOWNSHIP 2 SOUTH,
RANGE 5 EAST, W.M., CITY OF SANDY, CLACKAMAS COUNTY OREGON
JULY 21, 2023 SCALE: 1" = 40'

BOOK 155 PAGE 005

PLAT NO. 4714

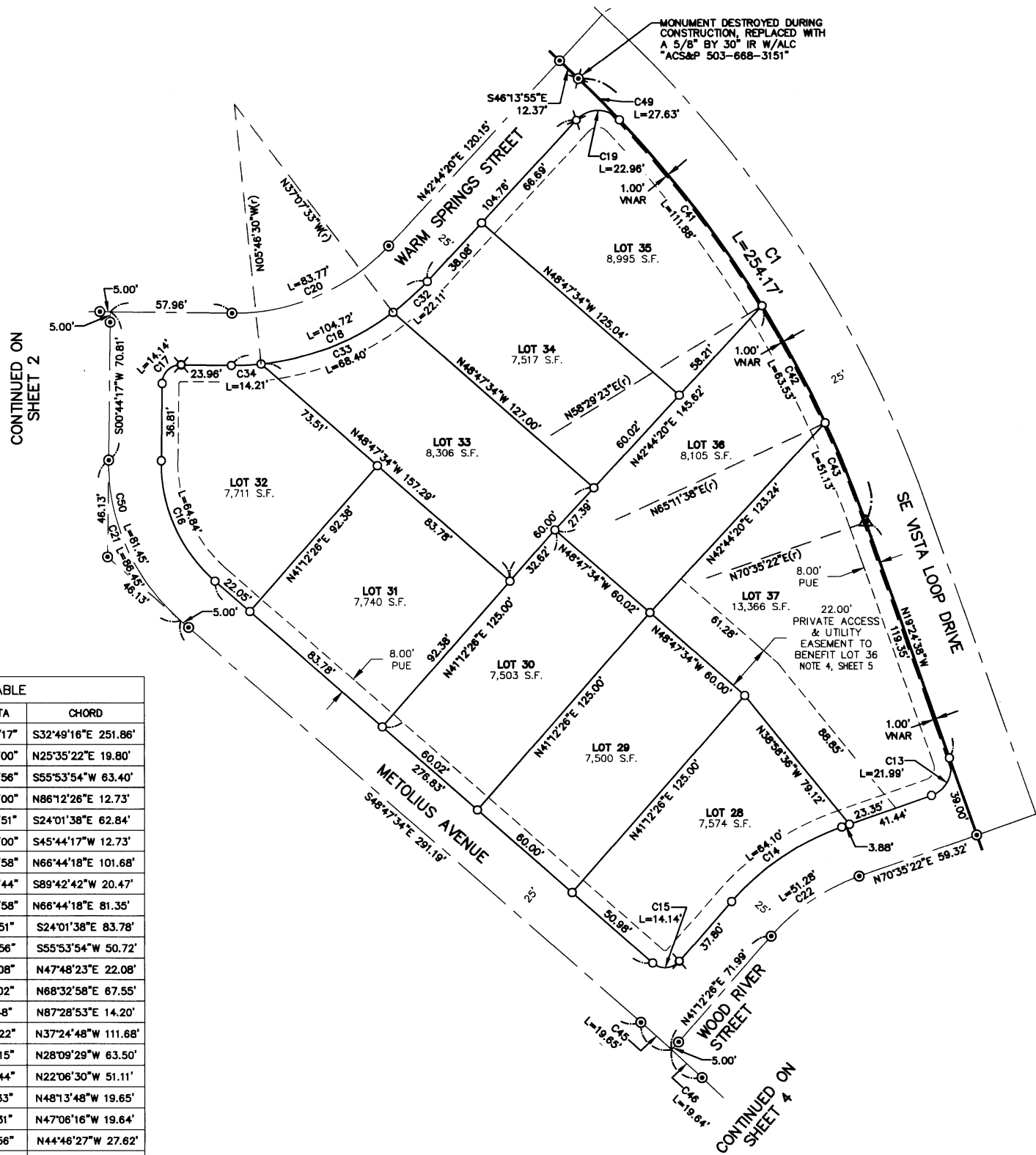

LEGEND

- ▲ 5/8" BY 30" IR W/YPC "ACS&P 503-668-3151" SET ON 9/5/2023.
- 5/8" BY 30" IR W/YPC MARKED "ACS&P 503-668-3151" SET ON 9/5/2023.
- ⊙ 5/8" BY 30" IR W/YPC MARKED "ACS&P 503-668-3151" IN MONUMENT BOX, SET ON 9/5/2023.
- ⊗ 5/8" BY 30" IR W/ALC MARKED "ACS&P 503-668-3151" SET ON 9/5/2023.
- ⊗ 1 1/2" BRASS DISK MARKED "ACS&P 503-668-3151" SET ON 9/5/2023.
- ▲ FOUND 5/8" IR W/YPC "ACS&P 668-3151", SET IN (R)10, HELD
- FOUND MONUMENT AS NOTED HEREON
- ⊗ FOUND 5/8" IR W/YPC "HULT 2427", SET IN (R)6, HELD
- ⊗ FOUND 5/8" IR W/YPC "ACS&P 503-668-3151", SET IN (R)4, HELD
- (r) RADIAL BEARING
- OU ORIGIN UNKNOWN
- W/ALC WITH ALUMINUM CAP, MARKED
- W/YPC INDICATES WITH YELLOW PLASTIC CAP, MARKED
- IR INDICATES IRON ROD
- IP INDICATES IRON PIPE
- PS INDICATES POINT OF SPIRAL CURVE
- PSC INDICATES POINT OF SPIRAL CURVE TO CIRCULAR CURVE
- PT INDICATES POINT OF TANGENCY
- SDE STORM DRAINAGE EASEMENT
- PUE PUBLIC UTILITY EASEMENT
- VNAR VEHICLE NON-ACCESS RESTRICTION, CONTROLLED BY THE CITY OF SANDY

CURVE TABLE				
CURVE	LENGTH	RADIUS	DELTA	CHORD
C1	254.17'	542.96'	26°49'17"	S32°49'16"E 251.86'
C13	21.99'	14.00'	90°00'00"	N25°35'22"E 19.80'
C14	64.10'	125.00'	29°22'56"	S55°53'54"W 63.40'
C15	14.14'	9.00'	90°00'00"	N86°12'26"E 12.73'
C16	64.84'	75.00'	49°31'51"	S24°01'38"E 62.84'
C17	14.14'	9.00'	90°00'00"	S45°44'17"W 12.73'
C18	104.72'	125.00'	47°59'58"	N66°44'18"E 101.68'
C19	22.96'	14.00'	93°56'44"	S89°42'42"W 20.47'
C20	83.77'	100.00'	47°59'58"	N66°44'18"E 81.35'
C21	86.45'	100.00'	49°31'51"	S24°01'38"E 83.78'
C22	51.28'	100.00'	29°22'56"	S55°53'54"W 50.72'
C32	22.11'	125.00'	10°08'08"	N47°48'23"E 22.08'
C33	68.40'	125.00'	31°21'02"	N68°32'58"E 67.55'
C34	14.21'	125.00'	6°30'48"	N87°28'53"E 14.20'
C41	111.88'	542.96'	11°48'22"	N37°24'48"W 111.68'
C42	63.53'	542.96'	6°42'15"	N28°09'29"W 63.50'
C43	51.13'	542.96'	5°23'44"	N22°06'30"W 51.11'
C45	19.65'	1000.00'	1°07'33"	N48°13'48"W 19.65'
C46	19.64'	1000.00'	1°07'31"	N47°06'16"W 19.64'
C49	27.63'	542.96'	2°54'56"	N44°46'27"W 27.62'
C50	81.45'	100.00'	46°39'57"	S22°35'41"E 79.21'
C51				DELETED
C52				DELETED
C53				DELETED

DRAWN: JTD CHECKED: LKF APPROVED: DLH

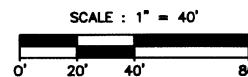

REGISTERED PROFESSIONAL LAND SURVEYOR

OREGON
JANUARY 23, 1990
DALE L. HULT
2427

RENEWS 07/01/2025

CLIENT: EVEN BETTER HOMES, INC.

Surveyors & Planners, Inc.
Surveying, Planning and Civil Engineering
P.O. Box 955 Sandy, OR 97055
Phone: (503) 668-3151
Fax: (503) 668-4730
Subject to General Conditions 2006 ©

DWG NUMBER: 19-071 - PLAT.dwg
SHEET 3 OF 5 DATE OF PLOT: 07-21-23

HOOD VIEW HEIGHTS

LOCATED IN THE NW 1/4 OF THE NE 1/4 OF SECTION 19, TOWNSHIP 2 SOUTH,
 RANGE 5 EAST, W.M., CITY OF SANDY, CLACKAMAS COUNTY OREGON
 JULY 21, 2023 SCALE: 1" = 40'

CURVE	LENGTH	RADIUS	DELTA	CHORD
C8	13.26'	9.00'	84°26'48"	N04°19'06"W 12.10'
C9	244.62'	53.00'	264°26'48"	N85°40'54"E 78.50'
C10	13.78'	9.00'	87°44'56"	S02°40'02"E 12.48'
C11	38.46'	75.00'	29°22'56"	S55°53'54"W 38.04'
C12	21.99'	14.00'	90°00'00"	N64°24'38"W 19.80'
C22	51.28'	100.00'	29°22'56"	S55°53'54"W 50.72'
C36	105.30'	53.00'	113°49'56"	S19°00'40"E 88.81'
C37	41.02'	53.00'	44°20'25"	N81°54'09"E 40.00'
C38	98.31'	53.00'	106°16'27"	N06°35'43"E 84.81'
C44	36.67'	975.00'	2°09'18"	N47°37'09"W 36.67'
C45	19.65'	1000.00'	1°07'33"	N48°13'48"W 19.65'
C46	19.64'	1000.00'	1°07'31"	N47°06'16"W 19.64'
C47	1.64'	975.00'	0°05'46"	N48°44'41"W 1.64'
C48	38.31'	975.00'	2°15'04"	N47°40'02"W 38.30'
C52				DELETED
C53				DELETED
C54	47.58'	53.00'	51°28'08"	N01°47'42"W 46.00'

LEGEND

- ▲ 5/8" BY 30" IR W/YPC "ACS&P 503-668-3151" SET ON 9/5/2023. OU ORIGIN UNKNOWN
- 5/8" BY 30" IR W/YPC MARKED "ACS&P 503-668-3151" SET ON 9/5/2023. W/ALC WITH ALUMINUM CAP, MARKED
- ⊙ 5/8" BY 30" IR W/YPC MARKED "ACS&P 503-668-3151" IN MONUMENT BOX, SET ON 9/5/2023. W/YPC INDICATES WITH YELLOW PLASTIC CAP, MARKED
- ⊗ 1 1/2" BRASS DISK MARKED "ACS&P 503-668-3151" SET ON 9/5/2023. IR INDICATES IRON ROD
- ⊗ 1 1/2" BRASS DISK MARKED "ACS&P 503-668-3151" SET ON 9/5/2023. IP INDICATES IRON PIPE
- ▲ FOUND 5/8" IR W/YPC "ACS&P 668-3151", SET IN (R)10, HELD. PS INDICATES POINT OF SPIRAL CURVE
- FOUND MONUMENT AS NOTED HEREON. PSC INDICATES POINT OF SPIRAL CURVE TO CIRCULAR CURVE
- ⊗ FOUND 5/8" IR W/YPC "HULT 2427", SET IN (R)6, HELD. PT INDICATES POINT OF TANGENCY
- FOUND 5/8" IR W/YPC "ACS&P 503-668-3151", SET IN (R)4, HELD. PUE PUBLIC UTILITY EASEMENT
- (r) RADIAL BEARING. VNRAR VEHICLE NON-ACCESS RESTRICTION, CONTROLLED BY THE CITY OF SANDY
- (R)8 INDICATES SURVEY NUMBER 1956-036, CLACKAMAS COUNTY SURVEY RECORDS
- (R)10 INDICATES SURVEY NUMBER SN2022-190, CLACKAMAS COUNTY SURVEY RECORDS

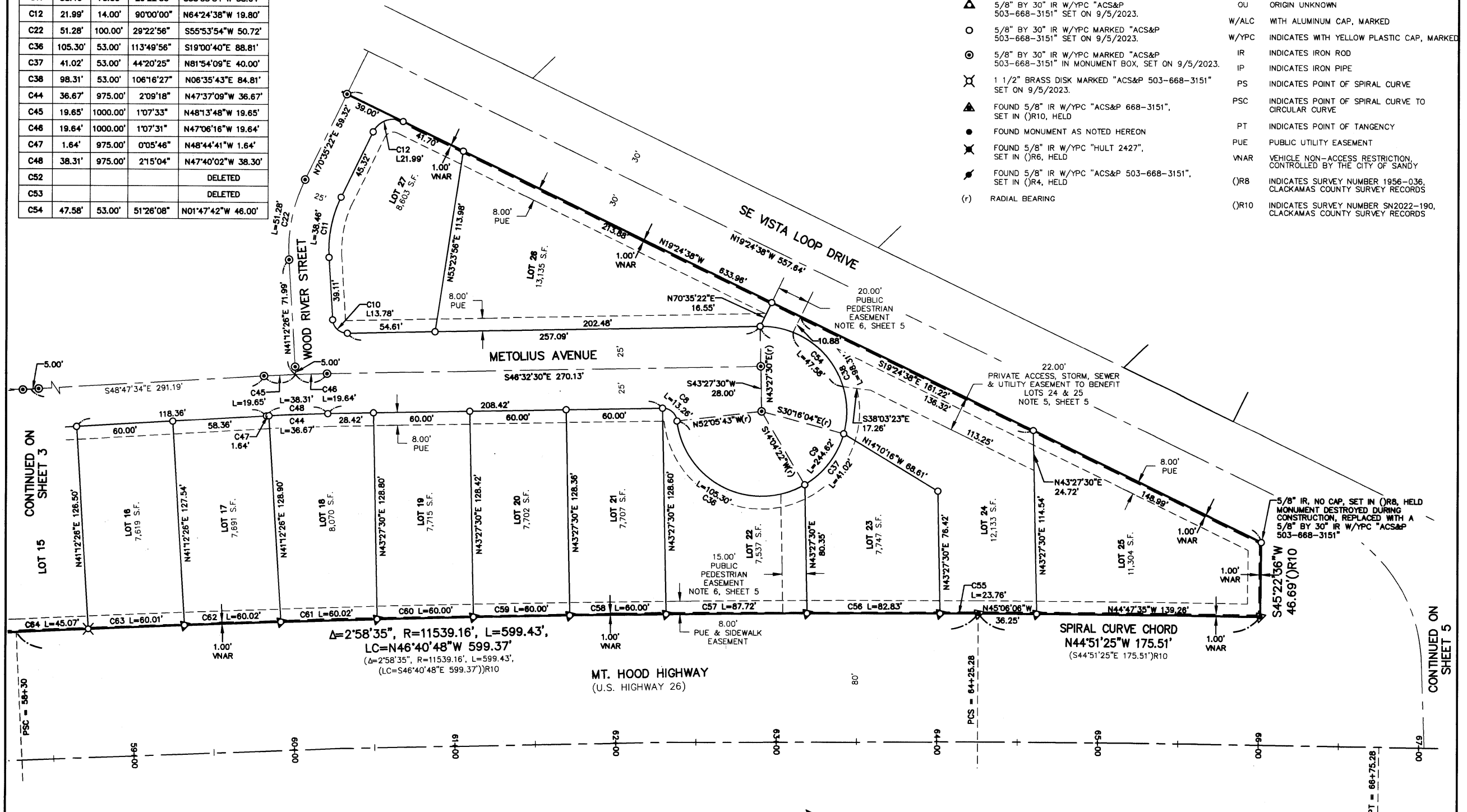

CURVE	LENGTH	RADIUS	DELTA	CHORD
C55	23.76'	11,539.16'	00°07'05"	N45°15'03"W 23.76'
C56	82.83'	11,539.16'	00°24'41"	N45°30'55"W 82.83'
C57	87.72'	11,539.16'	00°28'08"	N45°56'20"W 87.72'
C58	60.00'	11,539.16'	00°17'53"	N46°18'20"W 60.00'
C59	60.00'	11,539.16'	00°17'53"	N46°36'12"W 60.00'

CURVE	LENGTH	RADIUS	DELTA	CHORD
C60	60.00'	11,539.16'	00°17'53"	N46°54'05"W 60.00'
C61	60.02'	11,539.16'	00°17'53"	N47°11'58"W 60.02'
C62	60.02'	11,539.16'	00°17'53"	N47°29'51"W 60.02'
C63	60.01'	11,539.16'	00°17'53"	N47°47'43"W 60.01'
C64	45.07'	11,539.16'	00°13'28"	N48°03'22"W 45.07'



SCALE: 1" = 40'

REGISTERED PROFESSIONAL LAND SURVEYOR
 OREGON
 JANUARY 23, 1990
 DALE L. HULT
 2427
 RENEWS 07/01/2025

CLIENT: EVEN BETTER HOMES, INC.
All County
Surveyors & Planners, Inc.
 Surveying, Planning and Civil Engineering
 P.O. Box 955 Sandy, OR 97055
 Phone: (503) 668-3151
 Fax: (503) 668-4730
 Subject to General Conditions 2006 ©

DRAWN: JTD CHECKED: LKF APPROVED: DLH

DWG NUMBER: 19-071 - PLAT.dwg SHEET 4 OF 5 DATE OF PLOT: 07-21-23

HOOD VIEW HEIGHTS

LOCATED IN THE NW 1/4 OF THE NE 1/4 OF SECTION 19, TOWNSHIP 2 SOUTH, RANGE 5 EAST, W.M., CITY OF SANDY, CLACKAMAS COUNTY OREGON
JULY 21, 2023 SCALE: 1" = 40'

BOOK 155 PAGE 005

PLAT NO. 4714

APPROVALS

CITY OF SANDY FILE NO. 21-012 SUB/FSH/TREE
HOOD VIEW HEIGHTS SUBDIVISION
APPROVED THIS 14th DAY OF AUGUST 2023
BY: [Signature]
CITY OF SANDY
DEVELOPMENT SERVICES DIRECTOR

APPROVED THIS 14th DAY OF AUGUST 2023
BY: [Signature]
CITY OF SANDY
CITY ENGINEER

APPROVED THIS 6th DAY OF SEPTEMBER 2023
BY: [Signature]
CLACKAMAS COUNTY SURVEYOR; AND
CLACKAMAS COUNTY BOARD OF
COMMISSIONERS DELEGATE PER COUNTY
CODE 11.02

ALL TAXES, FEES, ASSESSMENTS AND OTHER CHARGES AS
PROVIDED BY O.R.S. 92.095 HAVE BEEN PAID THROUGH
JUNE 30, 2024

APPROVED THIS 6th DAY OF SEPTEMBER 2023
CLACKAMAS COUNTY ASSESSOR & TAX COLLECTOR
BY: [Signature]
DEPUTY

STATE OF OREGON s.s.
COUNTY OF CLACKAMAS
I DO HEREBY CERTIFY THAT THE ATTACHED PLAT WAS RECEIVED
FOR RECORD ON THE
7th DAY OF SEPTEMBER 2023
AT 11:03 O'CLOCK A.M.

AS PLAT NO. 4714
DOCUMENT NO. 2023-032240
CATHERINE McMULLEN, CLACKAMAS COUNTY CLERK
BY: [Signature]
DEPUTY

DECLARATION

KNOW ALL PERSONS BY THESE PRESENTS THAT EVEN BETTER HOMES, INC., IS THE OWNER OF THE LAND DEPICTED HEREON AND DESCRIBED IN THE ACCOMPANYING SURVEYOR'S CERTIFICATE, AND HAS CAUSED THIS REPLAT TO BE PREPARED AND THE PROPERTY PLATTED IN ACCORDANCE WITH THE PROVISIONS OF O.R.S CHAPTER 92. FURTHERMORE, THE DECLARANT HEREBY DEDICATES TO THE PUBLIC AS PUBLIC WAYS FOREVER THE RIGHTS-OF-WAY AS SHOWN HEREIN, AND DOES HEREBY GRANT ALL EASEMENTS FOR PUBLIC AND PRIVATE USE AS SHOWN AND NOTED HEREIN. THE PLATTED PROPERTY IS SUBJECT TO RESTRICTIONS AND CONDITIONS NOTED HEREON.

[Signature]
ERICH EVEN - PRESIDENT
EVEN BETTER HOMES, INC

ACKNOWLEDGMENT

COUNTY OF CLACKAMAS
STATE OF OREGON
KNOW ALL MEN BY THESE PRESENTS THAT ON July 26th 2023 BEFORE ME A NOTARY PUBLIC IN AND FOR SAID COUNTY AND STATE PERSONALLY APPEARED ERICH EVEN, WHOM BEING FIRST DULY SWORN DID SAY THAT HE IS THE IDENTICAL PERSON NAMED IN THE FOREGOING INSTRUMENT, AND THAT SAID INSTRUMENT WAS EXECUTED ON BEHALF OF EVEN BETTER HOMES, INC. AS A PRESIDENT FREELY AND VOLUNTARILY.

[Signature]
NOTARY SIGNATURE

Scott Morcom
NOTARY PUBLIC- OREGON
COMMISSION NO. 1022774
MY COMMISSION EXPIRES: March 22, 2026

SURVEYOR'S NARRATIVE

THE PURPOSE OF THIS SURVEY IS TO SUBDIVIDE THE PROPERTY DESCRIBED IN SURVEY NO. 2022-018503, CLACKAMAS COUNTY DEED RECORDS, LOCATED IN THE NE 1/4 SECTION 19, T2S, R5E, W.M., INTO LOTS PER THE CITY OF SANDY COMMUNITY DEVELOPMENT FILE NO. 21-012 SUB/FSH/TREE. THE BASIS OF BEARING WAS ESTABLISHED BY HOLDING MONUMENTS "A" AND "B", HAVING A RECORD BEARING OF S89°15'43"E PER SN2022-190. THE BOUNDARY WAS HELD AS PREVIOUSLY ESTABLISHED IN SAID SURVEY.

SUBDIVISION PLAT CONSENT AFFIDAVIT

A SUBDIVISION PLAT CONSENT AFFIDAVIT BY Construction Loan Services II, LLC BENEFICIARY UNDER DEED OF TRUST (or OWNER UNDER VESTING DEED) RECORDED IN INSTRUMENT NO. 2023-017799 HAS BEEN EXECUTED AND RECORDED IN INSTRUMENT NO. 2023-032239 OF THE CLACKAMAS COUNTY DEED RECORDS.

SURVEYOR'S CERTIFICATE

I DALE L. HULT, HEREBY CERTIFY THAT I HAVE CORRECTLY SURVEYED AND MARKED WITH PROPER MONUMENTS THE LAND REPRESENTED ON THIS MAP, BEING DESCRIBED IN FEE NUMBER 2022-018503, CLACKAMAS COUNTY DEED RECORDS, SITUATED IN THE NE 1/4 OF SECTION 19, TOWNSHIP 2 SOUTH, RANGE 5 EAST OF THE WILLAMETTE MERIDIAN, IN THE CITY OF SANDY, COUNTY OF CLACKAMAS AND STATE OF OREGON. SAID LAND BEING MORE PARTICULARLY DESCRIBED AS FOLLOWS:

COMMENCING FROM THE NORTH 1/4 CORNER OF SECTION 19 MARKED WITH A 3 1/4" BRONZE DISK STAMPED PER USBT ENTRY 2007-049; THENCE S89°15'43"E, A DISTANCE OF 182.22 FEET TO THE INITIAL POINT, SAID POINT BEING 80 FEET FROM, WHEN MEASURED AT RIGHT ANGLES TO, THE CENTERLINE OF SAID MOUNT HOOD HIGHWAY 26, SAID POINT ALSO BEING ON THE SOUTH LINE OF "RUSCHKA PLACE SUBDIVISION", CLACKAMAS COUNTY PLAT RECORDS; THENCE S89°15'43"E ALONG THE SAID SOUTH LINE OF SAID "RUSCHKA PLACE SUBDIVISION", CLACKAMAS COUNTY PLAT RECORDS, A DISTANCE OF 727.10 FEET, TO A POINT ON THE WEST RIGHT OF WAY LINE OF SAID SE VISTA LOOP DRIVE; THENCE FOLLOWING THE SAID WEST RIGHT OF WAY LINE OF SAID SE VISTA LOOP DRIVE, 30 FEET FROM AND PARALLEL WITH THE CENTERLINE OF SAID SE VISTA LOOP DRIVE, THE FOLLOWING COURSES AND DISTANCES; THENCE S46°13'55"E, A DISTANCE OF 52.85 FEET TO A POINT OF CURVATURE; THENCE ALONG A 542.96 FOOT RADIUS TANGENT CURVE TO THE RIGHT, AN ARC DISTANCE OF 254.17 FEET, THROUGH A CENTRAL ANGLE OF 26°49'17" (LONG CHORD BEARS SOUTH 32°49'16" EAST 251.86 FEET); THENCE S19°24'38"E, A DISTANCE OF 792.32 FEET TO A 5/8" IRON ROD WITH NO CAP, FOUND ON THE SAID WEST RIGHT OF WAY LINE OF SAID SE VISTA LOOP DRIVE, SAID POINT ALSO BEING THE SOUTHEASTERLY CORNER OF FEE NUMBER 2022-018503; THENCE S45°22'36"W, A DISTANCE OF 46.69 FEET TO A POINT OF CURVATURE, SAID POINT ALSO BEING THE MOST SOUTHERLY CORNER OF SAID FEE NUMBER 2022-018503, SAID POINT ALSO BEING THE INTERSECTION OF SAID WEST RIGHT OF WAY LINE OF SAID SE VISTA LOOP DRIVE AND THE EAST RIGHT OF WAY LINE OF MOUNT HOOD HIGHWAY 26; THENCE FOLLOWING THE SAID EAST RIGHT OF WAY LINE OF SAID MOUNT HOOD HIGHWAY 26, 80 FEET FROM AND PARALLEL WITH THE CENTERLINE OF SAID MOUNT HOOD HIGHWAY 26, THE FOLLOWING COURSES AND DISTANCES; THENCE ALONG A SPIRAL CURVE TO THE LEFT WITH A CHORD BEARING OF N44°51'25"W, A DISTANCE OF 175.51' TO A POINT OF COMPOUND CURVATURE; THENCE ALONG AN 11,539.16 FOOT RADIUS TANGENT CURVE TO THE LEFT, AN ARC DISTANCE OF 599.43 FEET, THROUGH A CENTRAL ANGLE OF 2°58'35" (LONG CHORD BEARS N46°40'48"W 599.37 FEET) TO A POINT OF OF CURVATURE; THENCE ALONG A SPIRAL CURVE TO THE LEFT WITH A CHORD BEARING OF N48°35'04"W, A DISTANCE OF 250.87'; THENCE N48°47'35"W, A DISTANCE OF 510.15 FEET, TO THE INITIAL POINT.

CONTAINING AN AREA OF 9.55 ACRES, MORE OR LESS.

AS PER ORS 92.060(5) AND 92.070(2), I CERTIFY THAT THE REMAINING MONUMENTS IN THIS SUBDIVISION PLAT WILL BE SET WITHIN 90 CALENDAR DAYS AFTER COMPLETION OF PAVING IMPROVEMENTS AND PRIOR TO ONE YEAR AFTER PLAT RECORDATION, WHICHEVER COMES FIRST.

REMAINING CORNER MONUMENTATION

IN ACCORDANCE WITH ORS 92.070, THE REMAINING CORNERS IN THIS A SUBDIVISION PLAT ACROSS TAX LOT NUMBER 500 HAVE BEEN CORRECTLY SET WITH PROPER MONUMENTS. AN AFFIDAVIT HAS BEEN PREPARED REGARDING THE SETTING OF SAID MONUMENTS AND WAS RECORDED ON IN DOCUMENT NO. _____, CLACKAMAS COUNTY DEED RECORDS.

CLACKAMAS COUNTY SURVEYOR
APPROVED THIS _____ DAY OF _____ 20____
BY: _____
CLACKAMAS COUNTY SURVEYOR

NOTES AND RESTRICTIONS:

- 1. THIS PLAT IS SUBJECT TO THE CONDITIONS OF APPROVAL IMPOSED BY THE CITY OF SANDY PLANNING FILE NO. 21-012 SUB/FSH/TREE.
- 2. TRACT "A" IS CONVEYED TO THE CITY OF SANDY RECORDED IN DOCUMENT NO. 2023-032245 CLACKAMAS COUNTY DEED RECORDS, FOR PUBLIC STORM WATER DETENTION FACILITIES TO BE OWNED AND MAINTAINED BY THE CITY OF SANDY.
- 3. A VEHICLE NON-ACCESS RESTRICTION (VNAR) GRANTED TO THE CITY OF SANDY, SHALL EXIST FOR TRACT A AND LOTS 9, 11-25 ALONG THE RIGHT-OF-WAY OF HIGHWAY 26 AND FOR LOTS 1, 24-27 AND 35-37 ALONG THE RIGHT-OF-WAY OF SE VISTA LOOP DRIVE.
- 4. PRIVATE ACCESS AND UTILITY EASEMENT OVER LOT 37, BENEFITING LOT 36 IS SUBJECT TO A MAINTENANCE AGREEMENT AS RECORDED IN DOCUMENT NO. 2023-032242, CLACKAMAS COUNTY DEED RECORDS.
- 5. PRIVATE ACCESS, STORM, SEWER AND UTILITY EASEMENT OVER LOT 24, BENEFITING LOTS 24 & 25 IS SUBJECT TO A MAINTENANCE AGREEMENT AS RECORDED IN DOCUMENT NO. 2023-032243 CLACKAMAS COUNTY DEED RECORDS.
- 6. PUBLIC PEDESTRIAN EASEMENTS ARE GRANTED TO THE CITY OF SANDY AS SHOWN ON THE PLAT AND ARE TO BE MAINTAINED BY THE CITY OF SANDY. Per Document No 2023-032241
- 7. PRIVATE UTILITY EASEMENT OVER LOTS 1, 2, 3, 4, 5, 6, 7 & 8 BENEFITING LOTS 1, 2, 3, 4, 5, 6, 7 & 8 IS SUBJECT TO A MAINTENANCE AGREEMENT AS RECORDED IN DOCUMENT NO. 2023-032244 CLACKAMAS COUNTY DEED RECORDS.

REGISTERED PROFESSIONAL LAND SURVEYOR

OREGON
JANUARY 23, 1990
DALE L. HULT
2427

RENEWS 07/01/23

CLIENT: EVEN BETTER HOMES, INC.

All County Surveyors & Planners, Inc.
Surveying, Planning and Civil Engineering
P.O. Box 955 Sandy, OR 97055
Phone: (503) 668-3151
Fax: (503) 668-4730
Subject to General Conditions 2006 ©

DRAWN: JTD CHECKED: LKF APPROVED: DLH

DWG NUMBER: 19-071 - PLAT.dwg
SHEET 5 OF 5 DATE OF PLOT: 07-21-23

Exhibit B: Cedar Creek Heights Construction Plan Sheet

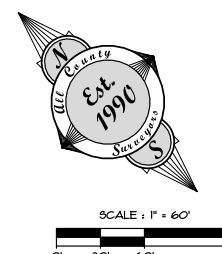
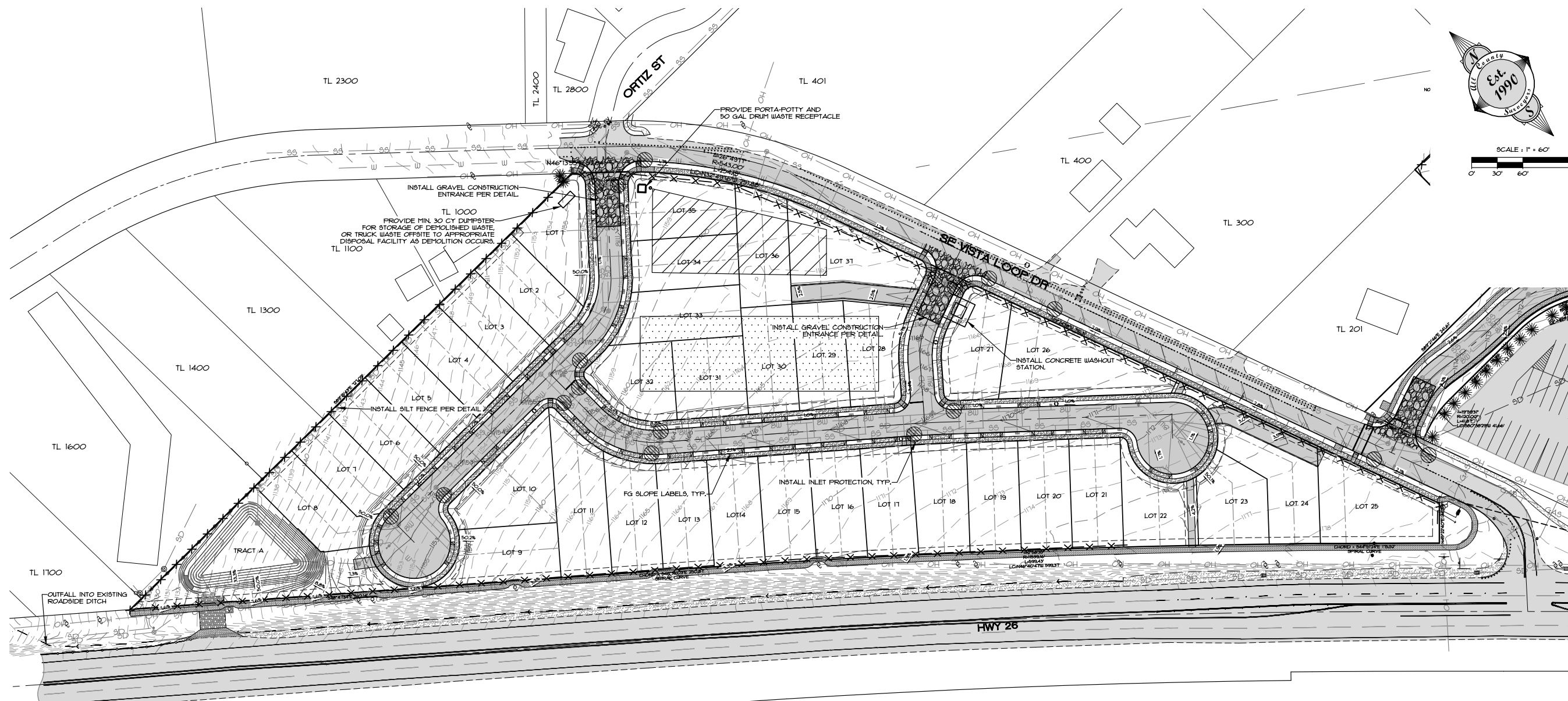

SHEET		EC6	
OF		11	
DESIGNED:	CTH	CHECKED:	RLM
DRAWN:	RLM/CTH	APPROVED:	RLM

SCALE	VERT. N/A	HORIZ. 1" = 60'
DATE:	06/15/2021	
FILE:	19-07-DESIGN.dwg	
SECTION	TWP.	RANGE
19	25	5E

CEDAR CREEK HEIGHTS
LOTS 1-31 STREET CONSTRUCTION
AND COMPLETION OF GRADING
PLAN

LOCATION: **4177 HWY 26, SANDY, OR 97055**

Surveyors & Planners, Inc.
 Surveying, Planning and
 Civil Engineering
 P.O. Box 945, Sandy, OR 97055
 Phone: (503) 688-4731
 Fax: (503) 688-4730

CLIENT:
EBHinc
 EVEN BETTER HOMES, INC.
 MAC EYVEN
 PO BOX 2021
 GRESHAM, OR 97030
 ebhinc@ebhinc.com
 PHONE: (503) 348-5600

NOTES
 TOTAL SITE AREA = 432.81 ACRES
 TOTAL DISTURBED AREA = 424.85 ACRES

- PROJECT SITE OUTSIDE OF THE 100-YEAR FLOODPLAIN.
- NO WORK SHALL BE DONE WITHIN THE RESTRICTED DEVELOPMENT AREA (RDA) OF THE PHASE 2 SITE. SILT FENCE AND TREE PROTECTION FENCING (WHERE APPLICABLE) SHALL BE USED TO DENOTE LIMITS OF DISTURBANCE. ALL EXISTING VEGETATION SHALL BE LEFT UNDISTURBED WITHIN THE RDA.
- SITE TO BE CLEARED AND GRUBBED WITHIN LIMITS OF DISTURBANCE. EXISTING TREES TO BE REMOVED PER PLAN. SITE TO BE SEEDED AND STABILIZED UPON CONSTRUCTION COMPLETION.
- A WATER TRUCK SHALL BE ON-SITE TO WET EXPOSED SOILS AND PREVENT BLOWING DUST.
- STREETS SHALL BE SWEEP CLEAN AS NEEDED AT THE END OF THE CONSTRUCTION DAY IF TRACKING OCCURS ONTO THE PUBLIC ROADS. A STREET SWEEPER SHALL BE MADE AVAILABLE TO ACCOMMODATE THIS NEED.
- WHEN GRADING IS COMPLETE, SEED EXPOSED SOILS WITH GRASS MIX PER ECI.
- DISTURBED SOIL THAT WILL REMAIN UNWORKED FOR 14 DAYS OR MORE SHALL BE COVERED IN BLOWN STRAW UNTIL PERMANENT SEEDING ESTABLISHES 10% VEGETATIVE COVER.

VOLUMES
 TOTAL CUT: 13,560 CY
 TOTAL FILL: 21,110 CY
 TOTAL VOLUME OF EARTHWORK: 34,670 CY

LEGEND

	INSTALL GRAVEL CONSTRUCTION ENTRANCE		INSTALL CATCH BASIN INLET PROTECTION ON NEW CBS
	CONSTRUCTION STAGING AREA		INSTALL CONCRETE TRUCK WASHOUT STATION
	STOCKPILE AREA		INSTALL SILT FENCE
	PROPOSED FINISH GRADE CONTOUR		EXISTING GROUND CONTOUR

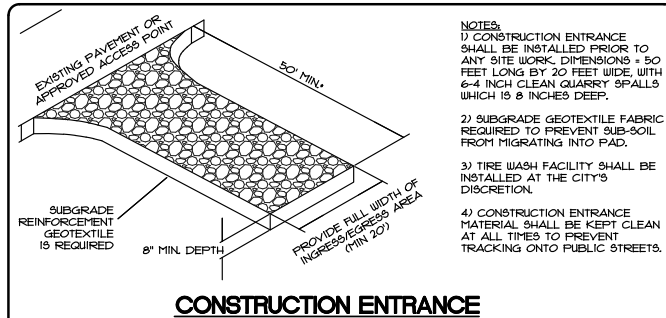
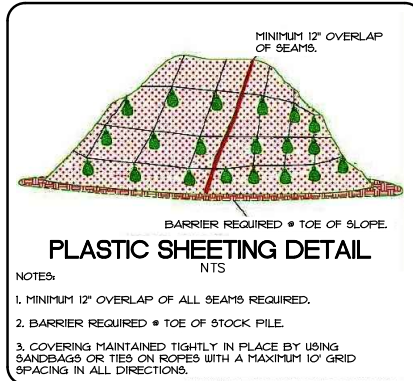
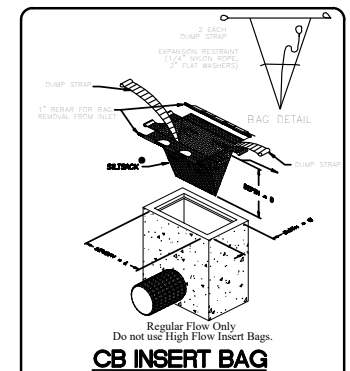
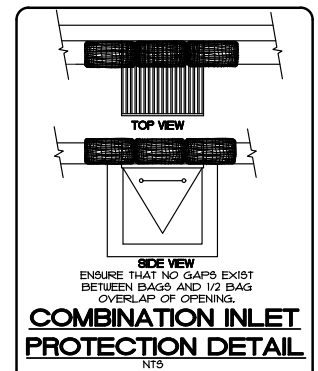

SILT FENCE NOTES

THE FILTER FABRIC SHALL BE PURCHASED IN A CONTINUOUS ROLL CUT TO THE LENGTH OF THE BARRIER TO AVOID USE OF JOINTS. WHEN JOINTS ARE NECESSARY, FILTER CLOTH SHALL BE SPICED TOGETHER ONLY AT A SUPPORT POST, WITH A MINIMUM 6-INCH OVERLAP, AND BOTH ENDS SECURELY FASTENED TO THE POST.

THE FILTER FABRIC FENCE SHALL BE INSTALLED TO FOLLOW THE CONTOURS. THE FENCE POSTS SHALL BE SPACED A MAXIMUM OF 6 FEET APART AND DRIVEN SECURELY INTO THE GROUND A MINIMUM OF 24 INCHES.

SEDIMENT FENCES SHALL BE REMOVED WHEN THEY HAVE SERVED THEIR USEFUL PURPOSE, BUT NOT BEFORE THE UP-SLOPE AREA HAS BEEN PERMANENTLY STABILIZED.

SEDIMENT FENCES SHALL BE INSPECTED BY APPLICANT/CONTRACTOR IMMEDIATELY AFTER EACH RAINFALL AND AT LEAST DAILY DURING PROLONGED RAINFALL. ANY REQUIRED REPAIRS SHALL BE MADE IMMEDIATELY.

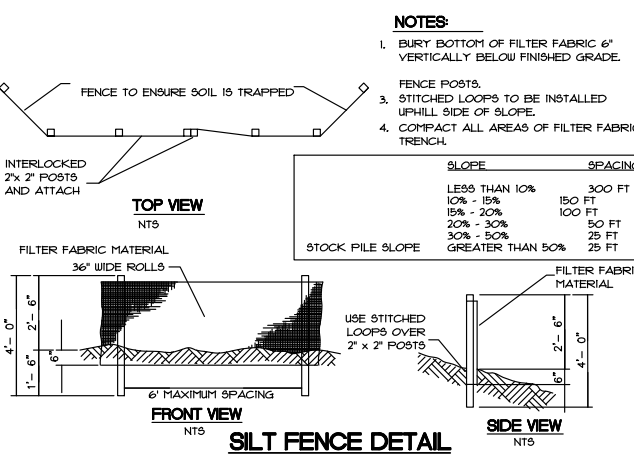

Exhibit C: Notice of Decision
(City File No. 21-012 SUB/FSH/TREE)

NOTICE OF LAND USE DECISION

NOTICE DATE: June 15, 2021

THIS NOTICE IS MAILED TO AGENCIES AND PEOPLE WITH APPEAL STANDINGS: ODOT, Sandy Fire District, Georgina Sutherland, Mac Even with Even Better Homes, Mike Robinson, existing property owners Picking and Knapp, and other applicant consultants

FROM: City of Sandy Development Services Department

STAFF CONTACT: Shelley Denison, Associate Planner, 503-783-2587, sdenison@ci.sandy.or.us

FILE NO.: 21-012 SUB/FSH/TREE Cedar Creek Heights Subdivision

EXPLANATION OF THE PROPOSAL: The applicant, Even Better Homes, has proposed an 89-lot subdivision on the subject properties adjacent to Vista Loop Drive, just east of Highway 26. These properties total 32.87 acres. Both parcels are zoned SFR, Single Family Residential. The homes on the proposed lots may be a mix of detached single-family homes and duplexes. This mix of housing will be determined at time of building permit submission. The proposal includes three stormwater tracts, four private drive tracts, three open space tracts, and a public park dedication tract. The application required a review of the flood and slope hazard overlay, as well as a review of tree removal plans.

EXPLANATION OF THE DECISION: The request by Even Better Homes to develop an 89-lot subdivision was approved by Development Services Department staff with conditions in accordance with a June 15, 2021, Final Order.

APPLICANT: Even Better Homes

PROPERTY OWNERS: Brad Picking and John Knapp

ADDRESS: East and West of the eastern end of Vista Loop Drive, east of Highway 26

LEGAL DESCRIPTION: 25E 19, Tax Lots 200 and 500

DECISION PROCESS: This notice is to inform you that a decision has been issued on the above referenced land use file. This decision will not become final until 12 days following the date of the decision. Any person adversely affected or aggrieved by the decision, or any person entitled to notice of the decision may appeal the decision in a manner consistent with the City's land use procedures. An appeal of this decision cannot be made directly to the Land Use Board of Appeals. An appeal can be made to the Planning Commission by filing an appeal, accompanied by an appeal fee, with the Development Services Director within 12 calendar days of notice of the decision.

FOR MORE INFORMATION: Additional information is available by sending an email to planning@ci.sandy.or.us or visiting the City of Sandy website. A copy of the final decision, summarizing the standards and facts that justified the decision is available upon request. In addition, all documents and evidence submitted with this application are also available for review. Additional copies are available at a reasonable cost.

**FINDINGS OF FACT and FINAL ORDER
TYPE II LAND USE DECISION**

DATE: June 15, 2021

FILE NO.: 21-012 SUB/FSH/TREE

PROJECT NAME: Cedar Creek Heights

APPLICANT: Mac Even, Even Better Homes

OWNERS: Brad Picking, John Knapp

LEGAL DESCRIPTION: 25E 19, Tax Lots 200 and 500

The above-referenced proposal was reviewed concurrently as a Type II subdivision, Flood and Slope Hazard (FSH) overlay review, and tree removal permit. The following exhibits, findings of fact, and conditions (bold text) explain the proposal and the conditions of approval.

EXHIBITS:

Applicant's Submittals:

- A. Land Use Application
- B. Project Narrative
- C. Civil Plan Set (March 2021)
 - Sheet 1 – Cover Sheet and Preliminary Plat Map
 - Sheet 2 – Preliminary Plat Map: Phase 1
 - Sheet 3 – Preliminary Plat Map: Phase 2
 - Sheet 4 – Topographic Survey: Phase 1
 - Sheet 5 – Topographic Survey: Phase 2
 - Sheet 6 – Tree Retention and Protection Plan
 - Sheet 7 – Tree Inventory List
 - Sheet 8 – Building Setbacks: Phase 1
 - Sheet 9 – Building Setbacks: Phase 2
 - Sheet 10 – Parking Analysis and Future Street Plan
 - Sheet 11 – Block and Street Dimensions
 - Sheet 12 – Street and Utility Plan: Phase 1
 - Sheet 13 – Street and Utility Plan: Phase 2
 - Sheet 14 – Grading and Erosion Control Plan: Phase 1
 - Sheet 15 – Grading and Erosion Control Plan: Phase 2
- D. Arborist Report
- E. Wetland Delineation Report and DSL Wetland Concurrence

- F. Geotechnical Report
- G. Storm Drainage Report
- H. Traffic Impact Study
- I. Sewer Capacity Email (March 30, 2021)
- J. Letter from Applicant's Attorney (April 27, 2021)
- K. Revised Phase 2 Plat Map Showing New Street Layout, Parkland Dedication, and Trail Easement (May 26, 2021)
- L. Parkland Slope Analysis (June 2, 2021)
- M. Plant Key (August 3, 2020)

Agency Comments:

- N. John Replinger, Traffic Engineer (May 19, 2021)
- O. ODOT (May 21, 2021)
- P. Sandy Fire District Marshal (May 18, 2021)
- Q. Parks and Trails Advisory Board (May 19, 2021)
- R. Sandy Public Works (May 26, 2021)

Other Documents:

- S. Pre-app notes (February 1, 2021)

Public Comments:

- T. Georgina Sutherland (May 21, 2021)

FINDINGS OF FACT

General Overview

1. These findings are based on the applicant's submittals received on March 24, 2021, April 27, 2021, and May 26, 2021. Staff deemed the application incomplete on April 16, 2021. The application was deemed complete on April 27, 2021 and a 120-day deadline of August 25, 2021 was established.
2. This report is based upon the exhibits listed in this document, as well as agency comments and public testimony.
3. The subject site is approximately 32.87 acres. The site is located east and west of the eastern end of Vista Loop Drive, east of Highway 26.
4. The parcel has a Comprehensive Plan Map designation of Low Density Residential and a Zoning Map designation of SFR, Single Family Residential.
5. The applicant, Even Better Homes, requests a Type II Subdivision with Flood and Slope Hazard Overlay review and tree removal. The proposed name of the subdivision is Cedar Creek Heights.

6. The applicant is proposing an 89 lot development with 89 single family homes in accordance with the base zoning designation. The development is proposed to occur over two phases. Phase I (9.55 acres) will include the development west of Vista Loop Drive and Phase II (23.32 acres) will include the development east on Vista Loop Drive. Additionally, the applicant is proposing open space, parkland, and stormwater detention tracts. The detailed acreage in square feet with associated tract letters (bold are public dedicated tracts) is as follows:

Tract Letter	Purpose	Square Feet
Phase I		
A	Stormwater detention pond	20,539
Phase II		
B	Stormwater detention pond	31,027
C	Private open space (in FSH)	29,215
D	Private open space (in FSH)	233,414
E	Private open space (in FSH)	62,626
F	Stormwater detention pond	13,954
G	Private Driveway	2,820
H	Private Driveway	2,593
I	Private Driveway	2,099
J	Private Driveway	1,782
K	Parkland Dedication	12,653

7. Agency comments were received from the City Transportation Engineer, ODOT, the Parks and Trails Advisory Board, Fire District No. 72, and Public Works.
8. One written public comment has been entered into the record and can be found in Exhibit T. The public comment was from Georgina Sutherland who is opposed to the proposal.
9. Previously, the applicant proposed a Planned Development (PD) for the subject site called The Views PD. This PD was denied by City Council in February 2021. However, a number of exhibits from that application are relevant to this application and have been carried over.

17.30 – Zoning Districts

10. The subject site is zoned SFR, single family residential.
11. The total gross acreage for the entire property is 32.87 acres. After removal of the right-of-way (4.935 acres), proposed stormwater tracts (1.504 acres), and proposed dedicated parkland (0.29 acres) the net site area (NSA) for the subject property is reduced to 26.140 net acres. Additionally, the site also contains a restricted development area of 6.423 acres. When this is subtracted from the net site area, the resulting unrestricted site area (USA) is 19.718 acres.

12. The underlying zoning district allows a minimum of 3 and a maximum of 5.8 dwelling units per net acre of unrestricted site area. Minimum density = $19.718 \times 3 = 59.154$, rounded down to 59 units. Maximum density is the lesser of the two following formulas: NSA x 5.8 or USA x 5.8 x 1.5 (maximum allowable density transfer based on Chapter 17.60).

I. $26.140 \times 5.8 = 151.612$, rounded to 152 units

II. $19.718 \times 5.8 \times 1.5 = 171.547$, rounded to 172 units

13. As a result of these calculations, the density range for the subject property is a minimum of 59 units and a maximum of 152 units.

17.34– Single Family Residential (SFR)

14. The applicant is proposing single family homes in compliance with the permitted uses in the SFR zoning district per Section 17.34.10. With the adoption of House Bill 2001 any of the lots may contain a duplex if all other development code standards are met.

15. Section 17.34.30 contains the development standards for the subject zoning district.

16. Section 17.34.30(A) requires that the minimum area of all lots be 7,500 square feet. The proposed lots range in size from 7,500 square feet to 17,037 square feet. Section 17.34.30(B) requires that the average lot width be 60 feet. Section 17.34.30(C) requires a minimum lot frontage of 20 feet. All proposed lots on the submitted plat maps meet these requirements.

17. Sections 17.34.30(E) and 17.34.30(I) have standards for setbacks and building height requirements, respectively. **The applicant shall ensure that the requirements of Chapter 17.34 are met during building permit submission.**

18. Section 17.34.40(A) requires that water service be connected to all dwellings in the proposed subdivision. Section 17.34.40(B) requires that all proposed dwelling units be connected to sanitary sewer service. Section 17.34.40(C) requires that the location of any real improvements to the property must provide for a future street network to be developed. Section 17.34.40(D) requires that all dwelling units must have frontage or approved access to public streets. The applicant proposes to meet all of these requirements. Each new home proposed to be constructed in the subdivision will gain access from a public street or private drive. Eight lots are proposed to gain access from four separate private drives connected to a public street.

19. Section 17.34.50(B) requires that lots with 40 feet or less of street frontage shall be accessed by a rear alley or shared private driveway. The only lots with less than 40 feet of street frontage are lots 68 and 69. These lots are proposed to be accessed by a shared private driveway.

17.56 – Hillside Development

20. The applicant submitted a Geotechnical Report (Exhibit F) showing that the subject site contains a small area of slope in Phase II exceeding 25 percent. **All recommendations in the conclusions and recommendations section of the Geotechnical Report (Exhibit F) shall be conditions for development.**

17.60 – Flood and Slope Hazard (FSH) Overlay District

21. Section 17.60.00 specifies the intent of the Flood and Slope Hazard (FSH) Overlay District, which is to promote the public health, safety and general welfare by minimizing public and private adverse impacts from flooding, erosion, landslides or degradation of water quality consistent with Statewide Planning Goal 6 (Air, Land and Water Resources Quality) and Goal 7 (Areas Subject to Natural Disasters and Hazards) and the Sandy Comprehensive Plan (SCP). **A violation of the provisions set forth in Chapter 17.60, FSH, (e.g. tree removal without permit authorization or native vegetation removal) may result in a fine as specified in Section 17.06.80.**

22. Section 17.60.20 contains permitted uses in the FSH overlay district and Section 17.60.40 contains the FSH review procedures. While lots 40, 41, and 42 overlap with the FSH overlay, the applicant is not proposing any development within the restricted development area of the FSH overlay district. The portions of lots 40, 41, and 42 platted within the FSH overlay are located within the required rear setbacks for these lots. **Any future development within the FSH overlay district shall require separate permit review. The applicant shall install fencing at the outer edge of the restricted development area of the FSH overlay district prior to grading to ensure no development occurs within the restricted development area of the FSH overlay.** The restricted development area is defined in Section 17.64.30. The submitted Tree Plan (Exhibit C, Sheet 6) states: “All dead or dying trees or vegetation that is hazardous to the public may be removed in accordance with Section 17.60.20.” However, the applicant did not provide any additional information regarding the potential location of dead or dying trees or vegetation that is hazardous to the public. Staff does not find how any vegetation would be hazardous to the public considering the area is not open to the public. **The applicant shall not remove any living or dead trees or vegetation from the FSH area without applying for an FSH review for their removal.** The grading plan does not indicate any grading will take place in the FSH overlay area, so staff assumes the applicant is not proposing to grade within the FSH. **The applicant shall not perform any grading activities or cut or fill in the FSH overlay area without applying for an FSH review for the grading/cut and fill.** The code does not allow removal of native vegetation from the FSH overlay nor does it allow planting non-native vegetation in the FSH overlay. **The applicant shall not remove any native vegetation from the FSH overlay area. The applicant shall not plant any non-native vegetation in the FSH overlay area.**

23. Section 17.60.30 outlines required setbacks for development around FSH areas. According to the topographic survey submitted with the application (Exhibit C, Sheets 4 and 5), no development is proposed within any of the required setback areas.

24. Section 17.60.50 contains requirements for special reports, including a hydrology and soils report, a grading plan, and a native vegetation report. The applicant submitted a Grading Plan (Exhibit C, Sheets 14 and 15) and a Wetland Delineation Report by Schott and Associates, LLC dated February 17, 2020 as well as DSL concurrence for the wetland report (Exhibit E). The applicant did not submit a native vegetation report. The Director may exempt Type II permit applications from one or more of these reports where impacts are minimal, and the exemption is consistent with the purpose of the FSH overlay zone as stated in Section 17.60.00.

25. Section 17.60.60 contains approval standards and conditions for development in the restricted development areas of the FSH overlay district. The applicant's narrative (Exhibit B) did not address any of the criteria in Section 17.60.60.
26. Section 17.60.60(A.1) pertains to cumulative impacts and states "Limited development within the FSH overlay district, including planned vegetation removal, grading, construction, utilities, roads and the proposed use(s) of the site will not measurably decrease water quantity or quality in affected streams or wetlands below conditions existing at the time the development application was submitted." The applicant submitted a wetland delineation report along with concurrence from DSL (Exhibit E) for tax lot 200. The wetland report identifies two wetlands and two streams on tax lot 200.
27. Section 17.60.60(A.2) pertains to impervious surface area and states, "Impervious surface area within restricted development areas shall be the minimum necessary to achieve development objectives consistent with the purposes of this chapter." **No impervious surfaces shall be located within the restricted development area.**
28. Section 17.60.60(A.3) pertains to construction materials and methods and states, "Construction materials and methods shall be consistent with the recommendations of special reports, or third-party review of special reports." **Future construction or development within the FSH overlay district shall require separate FSH review.**
29. Section 17.60.60(A.4) pertains to cuts and fills and states "Cuts and fills shall be the minimum necessary to ensure slope stability, consistent with the recommendations of special reports, or third-party review of special reports." The grading plan does not show any proposed grading within the FSH overlay area. **Future grading or other development activity within the FSH overlay district shall require separate FSH review.**
30. Section 17.60.60(A.5) pertains to minimizing wetland and stream impacts and states "Development on the site shall maintain the quantity and quality of surface and groundwater flows to locally significant wetlands or streams regulated by the FSH Overlay District." The applicant is proposing to add additional stormwater to the outflow in Tract L. **The applicant shall update the Geotech Report or submit an addendum to the Geotech Report that provides analysis of the new stormwater discharge.**
31. Section 17.60.60(A.6) pertains to minimizing loss of native vegetation and states "Development on the site shall minimize the loss of native vegetation. Where such vegetation is lost as a result of development within restricted development areas, it shall be replaced on-site on a 2:1 basis according to type and area. Two native trees of at least 1.5-inch caliper shall replace each tree removed. Disturbed understory and groundcover shall be replaced by native understory and groundcover species that effectively covers the disturbed area." The applicant is not proposing to remove any trees from the FSH overlay area nor is the applicant proposing to remove any native vegetation from the FSH overlay area. To better protect the vegetation within the FSH overlay area, **the applicant shall install tree protection fencing at the outer edge of the restricted development area in FSH overlay district.** The restricted development area is defined in Section 17.64.30. **The applicant shall not damage**

or remove any native vegetation within the FSH overlay district. The applicant shall replace any disturbed understory or groundcover with native understory or groundcover species that effectively cover the disturbed area. The applicant shall retain a qualified arborist on-site for any work done within the critical root zone (1 foot per 1 inch DBH) of retention trees including those within the FSH area to ensure minimum impact to trees and native vegetation.

32. Section 17.60.90 discusses water quality treatment facilities. The proposed detention ponds are not located within the mapped FSH overlay area.
33. Section 17.60.100 contains density transfer provisions. Due to the density calculation from Chapter 17.30, this site does not qualify for density transfer under Chapter 17.60.

17.80 – Additional Setbacks on Collector and Arterial Streets

34. Chapter 17.80 requires all residential structures to be setback at least 20 feet on collector and arterial streets. This applies to front, rear, and side yards. Vista Loop Drive is identified in the City's Transportation System Plan as a collector street. Highway 26 is a major arterial. As shown on the Block and Street Dimensions plan (Exhibit C, Sheets 8 and 9), it appears that all setbacks on lots adjacent to Vista Loop Drive and Highway 26 meet this requirement. **The applicant shall locate all structures a minimum of 20 feet from the property lines along Vista Loop Drive and Highway 26.**

17.82 – Special Setbacks on Transit Streets

35. Section 17.82.20(A) requires that all residential dwellings shall have their primary entrances oriented toward a transit street rather than a parking area, or if not adjacent to a transit street, toward a public right-of-way or private walkway which leads to a transit street. A transit street is defined as a street designated as a collector or arterial. Phase I is located adjacent to Highway 26, a major arterial, and Vista Loop Drive, a collector.
36. Sixteen (16) lots (lots 9 and 11-25) are proposed adjacent to Highway 26. Six (6) lots (lots 25-27 and 35-37) are proposed adjacent to Vista Loop Drive. Lot 25 has frontage on two transit streets as explained below. **The applicant shall orient the homes on lots 9, 11-27, and 35-37 toward their respective transit streets.**
37. Section 17.82.20(B) requires that dwellings shall have a primary entrance connecting directly between the transit street and building interior and outlines requirements for the pedestrian route. **The applicant shall ensure that primary entrances have a pedestrian connection to their respective transit streets. The pedestrian route shall consist of materials such as concrete, asphalt, stone, brick, permeable pavers, or other materials as approved by the Director. The pedestrian path shall be permanently affixed to the ground with gravel subsurface or a comparable subsurface as approved by the Director.**
38. Since houses have to orient to Vista Loop Drive and Highway 26 **the fences along Lots 9, 11-27, and 35-37 shall not exceed four (4) feet in height along their respective transit streets.**

39. Section 17.82.20(C) requires that primary dwelling entrances shall be architecturally emphasized and visible from the transit street and shall include a covered porch at least 5 feet in depth. The applicant proposes to meet this requirement.
40. Section 17.82.20(D) requires that if the site has frontage on more than one transit street, the dwelling shall provide one main entrance oriented to a transit street or to a corner where two transit streets intersect. Lot 25 has frontage on two transit streets. **Lot 25 shall either orient to Vista Loop Drive or Highway 26 or have a door that faces the intersection of the two subject streets. If a duplex is proposed on Lot 25 one front door may face Vista Loop Drive and the second front door may face Highway 26.**

17.84 – Improvements Required with Development

41. Section 17.84.20(A)(1) requires that all improvements shall be installed concurrently with development or be financially guaranteed. **All lots in the proposed subdivision will be required to install public and franchise utility improvements or financially guarantee these improvements prior to final plat approval. No building permits, except for one model home, will be issued until all public utilities including sanitary sewer and water service are available to serve the development and the City determines substantial completion of all public improvements. If the applicant chooses to install a model home, they shall commit to a Model Home Agreement with the City of Sandy.**
42. **All ADA ramps shall be designed and inspected by the design engineer and constructed by the applicant to meet the most current PROWAG requirements.**
43. Section 17.84.30(A)(1) requires that all proposed sidewalks on the local streets will be five feet wide as required by the development code and separated from curbs by a tree planting area that is a minimum of five feet in width. The applicant proposes to meet this requirement.
44. As required by Section 17.84.30(A)(2), six-foot sidewalks are proposed to be constructed along the arterial street of Highway 26 and the collector street of Vista Loop Drive. The applicant proposes to meet this requirement.
45. As required by Section 17.84.30(B), safe and convenient pedestrian and bicyclist facilities that strive to minimize travel distance to the extent practicable shall be provided in conjunction with new development within and between new subdivisions. Subsection 17.84.30(B)(2) goes on to elaborate that right-of-way connecting cul-de-sacs passing through unusually long or oddly shaped blocks shall be a minimum of 15 feet wide with eight (8) feet of pavement. **The applicant shall construct pedestrian connections from the Ortiz Street cul-de-sac to Highway 26 and from the Knapp Street cul-de-sac to both Vista Loop Drive and Highway 26 in order to ensure adequate pedestrian connection. The pedestrian connections from the Knapp Street cul-de-sac to Highway 26 and Vista Loop Drive may be located in a 15 foot wide easement. All three pedestrian connections shall consist of an 8 foot wide paved pathway, bollard lighting, and shall include vegetation.** To satisfy the standards of Subsection 17.84.30(B)(2) the applicant also needs to include a pedestrian connection from the cul-de-sac in Barrett Street to the property to the north. The pedestrian connection from the Mt. Hood Court cul-de-sac is satisfied with dedication of parkland and the blanket pedestrian easement on Tract D as explained in Chapter 17.86. **The**

applicant shall construct a pedestrian connection from the Barrett Street cul-de-sac to tax lot 25E1900401. The pedestrian connection from the Barrett Street cul-de-sac to tax lot 25E1900401 may be located in a 15 foot wide easement, but not located in Tract J. This pedestrian connection shall consist of an 8 foot wide paved pathway, bollard lighting, and shall include vegetation.

46. All sidewalk improvements shall be constructed according to city standards except the applicant is proposing to eliminate the landscape planter strip along a portion of the south side of Barrett Street from Vista Loop Drive to Bonnie Street in Phase II. As permitted by Section 17.84.30 (A)(3), elimination of a portion of the planter strip is due to the existing grade of the adjacent Johnson RV improvements requiring construction of a retaining wall and additional grading in this area. As shown on the Phase II Street and Utility Plan, a thick row of evergreen trees that were planted as part of the Johnson RV improvements will remain along this section. The proximity of these trees provide a visual screen of the RV dealership and will soften and enhance the pedestrian experience walking along the south side of Barrett Street.
47. Per the Public Works Director, **the applicant shall improve all public street frontages (including the Highway 26 right-of-way, and the street frontage of all tracts) in conformance with the requirements of Section 17.84.30 and Section 17.84.50.** The subject property contains frontage along Highway 26. The applicant's plan set shows a six-foot sidewalk is proposed to be constructed at the top of the bank along the site's entire highway frontage. The applicant's Engineer corresponded by email with the City's Public Works Director and an ODOT representative regarding if a curb will be required along the highway frontage. The Public Works Director indicated the decision on a curb is up to ODOT as they have authority over Highway 26. The ODOT representative stated that construction of a curb is not required along Highway 26 and construction of a sidewalk at the top of the bank is acceptable. With this, staff recommends the following condition: **Improvements adjacent to the site's Highway 26 frontage shall consist of a six-foot wide sidewalk constructed at the top of the bank, lighting, and street trees only as approved and permitted by ODOT.**
48. Section 17.84.40(A) requires that the developer construct adequate public transit facilities. Per previous correspondence, **the proposed development will require a concrete bus shelter pad and a green bench (Fairweather model PL-3, powder-coated RAL6028). The required pad size is 7 feet by 9.5 feet and should be located at the northernmost corner of Barrett Street and Vista Loop Drive. Engineering specifications are available from the Transit Department.**
49. Section 17.84.50 outlines the requirements for providing a traffic study. The applicant included a Traffic Impact Study (TIS) with the application (Exhibit H). The study did not identify any required mitigation. According to the traffic study, the proposed development would produce 67 peak AM trips, 89 peak PM trips, and 850 total daily trips. The findings from the City Transportation Engineer (Exhibit N) are expressly incorporated by reference into this document.

50. According to the TIS, the study intersections currently operate acceptably and are projected to continue to operate acceptably under year 2022 traffic conditions either with or without the addition of site trips from the proposed development. No queuing-related mitigations are necessary or recommended in conjunction with the proposed development. Based on the crash data, the study intersections are currently operating acceptably with respect to safety. Based on the warrant analysis, no new traffic signals or turn lanes are recommended. ODOT states (Exhibit O) that the applicant shall provide additional space on Highway 26 to accommodate westbound right turning movements from Highway 26 onto Vista Loop Drive. However, as was previously exhibited by the application for The Views PD, the applicant's traffic engineer and the City's traffic engineer disagree with this condition for a number of reasons. Primarily, the intersection has previously been improved to accommodate residential development by removing a right-turn slip lane from Highway 26 onto Vista Loop Drive. Staff and the City's engineer agree with the applicant's traffic analysis and will not condition a requirement for additional space to accommodate westbound right turns. **The applicant shall submit a profile design for a minimum of 200 feet for all future street extensions beyond the project boundary to ensure future street grades can be met.**
51. Intersection sight distance was evaluated for the proposed points of access along SE Vista Loop Drive. Based on the analysis it is projected that adequate site distance can be achieved for all proposed street intersections with clearing of vegetation from the roadside. No other sight distance mitigations are necessary or recommended.
52. The proposed development does not include any long straight street segments and is thus not required to follow the standards in Sections 17.84.50(C)(1) or (2).
53. Section 17.84.50(C)(3) requires that cul-de-sacs should generally not exceed 400 feet in length nor serve more than 20 dwelling units. Two cul-de-sacs are proposed in Phase I and three cul-de-sacs are proposed in Phase II. All proposed cul-de-sacs are less than 400 feet in length. Additionally, none of the cul-de-sacs will serve more than 12 lots.
54. Section 17.84.50(D) requires that development sites shall be provided with access from a public street improved to City standards. All homes will gain access from a public street improved to city standards or a private drive accessed from a public street. No off-site improvements have been identified or are warranted with the construction of this subdivision.
55. Section 17.84.50(E) requires that public streets installed concurrent with development of a site shall be extended through the site to the edge of the adjacent property. Temporary dead-ends created by this requirement to extend street improvements to the edge of the adjacent properties may be installed without turn-arounds, subject to the approval of the Fire Marshal. The proposed street layout results in one temporary dead-end street at the East end of Phase II. This street end includes sufficient room to accommodate fire equipment to turn around. The only existing street to be extended is Ortiz Street in Phase II, which is proposed to be located directly across Vista Loop Drive from the existing street. The applicant submitted a future street plan (Exhibit C, Sheet 10).
56. Section 17.84.50(F) requires that no street names shall be used that will duplicate or be confused with names of existing streets. The application includes proposed street names as

shown on submitted plans (Exhibit C). The applicant is proposing the following new street names: Knapp Street, Shannon Street, Barrett Street, Bonnie Street, and Mt. Hood Court. These proposed street names are not thematic and are not easy to identify for emergency responders. In addition, north/south right-of-way shall be identified as 'avenue'. **The City of Sandy reserves the right to name streets. The applicant and City staff shall identify new street names prior to final plat.**

57. Proposed streets meet the requirements of 17.84.50(H). The future street plan (Exhibit C, Sheet 1) shows that the proposed development will facilitate and not preclude development on adjacent properties, except with the possibility of the property north of Ortiz Street (i.e. Tax Map 25E18DC, Tax Lots 1000 and 1100). This is discussed in more detail in the subdivision approval criteria in Chapter 17.100 of this document. All proposed streets comply with the grade standards, centerline radii standards, and right-of-way improvement widths identified in Chapter 17.10, definition for 'street'. All proposed streets are designed to intersect at right angles with the intersecting street and comply with the requirements of Section 17.94.50.(H)(5). No private streets, with the exception of private drives, are proposed in the development.

58. The plans detail all street intersections provide at least 50 foot tangents as required per 17.84.50(H)(5)(C). **The vertical design grade for landing at all the Tee intersections where controlled with "Stop" signs shall be no greater than 8 percent for a minimum of 50 feet or two car lengths.**

59. Section 17.84.60 outlines the requirements of public facility extensions. The applicant submitted a utility plan (Exhibit C, Sheets 12 and 13) which shows the location of proposed public water, sanitary sewer, and stormwater drainage facilities. Broadband fiber service will be detailed with construction plans. No private utilities are proposed. **All public sanitary sewer and waterline mains are to be a minimum of 8 inches in diameter and storm drains are to be a minimum of 12 inches in diameter. These shall be extended to the plat boundaries where practical to provide future connections to adjoining properties. All utilities are extended to the plat boundary for future connections.**

60. According to the applicant's supplemental memo regarding sanitary sewer capacity dated July 17, 2020 from the previous application for The Views PD (Exhibit I), both the applicant and the city engineer anticipate adequate sewer capacity to accommodate new development:

"New commercial/residential loads are minor by comparison to the [infiltration and inflow] impact, and adding additional development has a nearly negligible impact on the system loading" (Exhibit I).

Additionally, the applicant suggests that SDC credits associated with the development will assist in paying for the City's existing plans to update the sanitary sewer system.

61. Franchise utilities will be provided to all lots within the proposed subdivision as required in Section 17.84.80. The location of these utilities will be identified on construction plans and installed or guaranteed prior to final plat approval. The applicant does not anticipate extending franchise utilities beyond the site. All franchise utilities other than streetlights will

be installed underground. The developer will make all necessary arrangements with franchise utility providers. The developer shall install underground conduit for street lighting.

62. Section 17.84.90 outlines requirements for land for public purposes. Eight-foot wide public utility easements will be provided along all lots adjacent to street rights-of-way for future franchise utility installations. **All easements and dedications shall be identified on the final plat as required.**
63. Section 17.84.100 outlines the requirements for mail delivery facilities. **The location and type of mail delivery facilities shall be coordinated with the City Public Works Director and the Post Office as part of the construction plan process. Phase I and Phase II shall each have their own mail facility to reduce unnecessary vehicular trips to retrieve mail.**
64. **SandyNet shall receive a set of PGE utility plans to design and return a SandyNet broadband deployment plan.**
65. There are two private storm drain lines crossing the proposed right-of-way of The Views Drive. These storm lines serve private developments to the south of the site. Private utility facilities serving single sites are not permitted in public rights-of-way. When the land use application for the private development south of the site was processed the City identified that the location of these lines would present a conflict if a public right-of-way was ever dedicated across these private lines. Staff believes there are three options available: 1) relocate these lines outside the public right-of-way; 2) Replace the existing lines with materials conforming to City standards or demonstrate that the pipeline materials comply with and were installed in conformance with City standards and dedicate these improvements as public; or, 3) Have the owner of the adjacent site served by these lines apply for a revocable permit to place private drainage facilities in a public right-of-way. **Since the exact location relative to proposed improvements in the right-of-way is unknown at this time the City will determine the most suitable option during construction plan review.**
66. **An ODOT Permit to Occupy or Perform Operations Upon a State Highway shall be obtained for all work in the State highway right-of-way.** When the total value of improvements within the ODOT right-of-way is estimated to be \$100,000 or more, an agreement with ODOT is required to address the ownership, maintenance, and operations of any improvements or alterations made in highway right-of-way. An Intergovernmental Agreement (IGA) is required for agreements involving local governments and a Cooperative Improvement Agreement (CIA) is required for private sector agreements. The agreement shall address the project standards that must be followed, compliance with ORS 276.071, which includes State of Oregon prevailing wage requirements, and any other ODOT requirements for project construction, including costs for ODOT staff time for project approvals, inspection, and completion.

17.86 – Parkland and Open Space

67. The Parks and Trails Advisory Board (Board) met on May 12, 2021. The Board recommended that conditions of approval include the dedication of a trail easement and land for a neighborhood park (Exhibit Q). The Board indicated the park should be at least two acres in size for active use and a passive area for trails. Based on the 1997 Parks Master Plan,

a neighborhood park is two to seven acres. Based on the parkland dedication formula in Section 17.86.10, the required parkland dedication for Cedar Creek Heights cannot exceed 1.15 acres (89 units x 3 x 0.0043) if single family homes are constructed, or 2.30 acres (178 units x 3 x 0.0043) if duplexes are constructed on every lot, or somewhere in between based on the mix of single-family and duplexes. The parks dedication requirement, and therefore a fee in-lieu payment under Section 17.86.40, is based on the impact from the number of people anticipated to live in the units in the subdivision, and a duplex includes two dwelling units, each of which can be occupied by a family (or a number of unrelated persons). Accordingly, each unit of a duplex is treated the same as a separate single-family dwelling for purposes of calculating the amount of land dedicated under Section 17.86.10 or a fee-in-lieu payment under Section 17.86.40. If parkland is dedicated, Section 17.86.20.C requires the parkland to have an average slope for the active use area that does not exceed 15 percent. However, the City of Sandy is not aware of any duplexes being proposed at this time. Therefore, the City of Sandy cannot require dedication of two acres of parkland and a trail easement as recommended by the Board. Furthermore, pursuant to ORS 197.195, the City cannot rely on the adopted parks master plan to require the dedication of land or impose other standards in the plan because the plan standards are not incorporated into the development code. Nothing in Chapter 17.86 refers to or in any way “incorporates” the City’s adopted parks master plan. Further, because the master plan does not apply, the City cannot require the parkland to be dedicated at a particular location that might accommodate future development or expansion of a two-acre neighborhood park.

68. After receiving the Board comments, the applicant revised its proposal to include dedicating an area for active parkland (approximately 12,653 square feet) and also a blanket trail easement over the entirety of Tract D (approximately 5.36 acres). The applicant’s proposed active parkland dedication area is interior to the site and therefore cannot be expanded to accommodate a future two-acre park. The area the applicant is proposing to dedicate for active parkland abuts Tract D and provides access to the future trail. Instead of obtaining parkland that does not meet the requirements of a neighborhood park (i.e. at least two acres) as desired by the Board, and to make sure to obtain some trail easements as also desired by the Board **the applicant shall dedicate at least 0.30 acres (13,068 square feet) for active parkland not exceeding an average slope of 15 percent as identified as Tract K, record a blanket pedestrian easement over the entirety of Tract D, and pay a parks fee in-lieu for the remaining 0.85 acres, or up to 2.00 acres if all lots are developed with duplexes. The fee in-lieu shall be \$204,850 (\$241,000 multiplied by 0.85 acres) if paid prior to recording of final plat, or \$225,250 (\$265,000 multiplied by 0.85 acres) if half is deferred to building permit issuance. If the applicant chooses to defer payment, the applicant shall pay \$112,625 prior to recording of final plat and the additional \$112,625 divided by the 89 lots, or \$1,265.45 with each building permit. Additionally, if any lot includes a duplex, the applicant shall pay an additional \$3,114.00 (1.15 multiplied by \$241,000 divided by 89) with the building permit for that lot. With this condition, the City finds the application complies with Section 17.86.10.**
69. In addition to the above requirements the applicant shall complete the following:
 - a. **Design the houses on Lots 67 and 68 to include at least ten (10) percent windows, at least two siding types, and a minimum of three additional design features from Section 17.90.150 facing the parkland tract.**

- b. **Complete all street improvements (including sidewalks) adjacent to the parkland tract at the applicant's expense.**
- c. **Grade the active parkland tract of 0.30 acres to accommodate playground equipment and seed the parkland with a seed mix as specified during construction plan review.**

17.90 – Design Standards

70. Chapter 17.90 contains design standards for development based on type and zone. **All future buildings shall adhere to the design standards in Chapter 17.90.** Single family homes will be reviewed at time of building permit submission.

17.92 - Landscaping and Screening

71. Section 17.92.30 requires the applicant to provide street trees along all public streets. **The street tree species shall be selected from the City of Sandy street tree list; due to concerns with Asian Longhorn Beetle and Emerald Ash Borer, staff are not approving maples or ashes as street trees at this time.** To improve species diversity, **the applicant shall include at least four (4) different tree species, with at least two (2) different species per street.**
72. **Street trees shall be installed approximately 30 feet on center in conjunction with individual home construction. Street trees along public stormwater tracts shall be installed with public improvements prior to final plat approval.** Trees planted along all other streets will be planted in association with development of individual lots. As specified in Section 17.92.50, **street trees shall be a minimum caliper of 1.5-inches measured 6 inches above grade. Street trees shall be planted per the City of Sandy standard planting detail; tree ties shall be loosely tied and removed after one growing season (or a maximum of 1 year). The planter strip shall be graded and backfilled as necessary, and bark mulch, vegetation, or other approved material installed prior to occupancy. In order to better protect newly planted trees, the applicant shall amend and aerate the soil within the planter strip 15 feet in both directions from where the tree will be planted (or as is feasible based on locations of driveways or street corners). The applicant shall submit documentation from the project landscaper stating that the soil has been amended and aerated prior to planting the street trees.**
73. The applicant did not address Section 17.92.40, related to irrigation of required landscaping. As required within Section 17.92.40 and 17.92.140, **the developer and/or lot owners shall maintain all vegetation planted in the development for two years unless otherwise noted and shall replace any dead or dying plants during that period.**
74. Per Subsection 17.92.130, if weather conditions or other circumstances beyond the control of the developer or owner make completion of the landscaping impossible prior to desired occupancy, an extension of up to 6 months may be applied for by posting "security" equal to 120 percent of the cost of the landscaping, assuring installation within 6 months.

17.98 – Parking, Loading, and Access Requirements

75. Section 17.98.10(M) requires that the developer provide a Residential Parking Analysis Plan. This plan identifying the location of parking is included in Exhibit C, Sheet 10.

76. Section 17.98.20(A) requires that each single family dwelling unit is required to provide at least two off-street parking spaces. **Compliance with this requirement will be evaluated during building plan review. Garages shall be at least 18 feet in depth to accommodate vehicle parking and the on-street parking spaces shall be at least 22 feet in length. All parking, driveway and maneuvering areas shall be constructed of asphalt, concrete, or other approved material.**
77. Section 17.98.60 has specifications for parking lot design and size of parking spaces. No lots are proposed to gain access from an arterial or collector street (Section 17.98.80).
78. Section 17.98.100 has specifications for driveways. **The minimum driveway approach width for a single-family dwelling shall be 10 feet and the maximum driveway approach within the public right-of-way shall be 24 feet wide measured at the bottom of the curb transition.** Shared driveway approaches may be required for adjacent lots in cul-de-sacs in order to maximize area for street trees and minimize conflicts with utility facilities (power and telecom pedestals, fire hydrants, streetlights, meter boxes, etc.). As shown on the applicant's submittal (Exhibit C), allowing each cul-de-sac lot to be accessed by a separate driveway complies with the requirements of this section. Additionally, all driveways will meet vertical clearance, slope, and vision clearance requirements. All driveways appear to meet these criteria, but this will be verified at time of building permit submission and prior to excavation for the footings. Per Section 17.98.100(G), **the sum of the width of all driveway approaches within the bulb of a cul-de-sac as measured in Section 17.98.100(B) shall not exceed fifty percent of the circumference of the cul-de-sac bulb.** Section 17.98.100(I), **driveways shall taper to match the driveway approach width to prevent stormwater sheet flow from traversing sidewalks.**
79. Section 17.98.110 outlines the requirements for vision clearance. **The requirements of this section shall be considered in placing landscaping in these areas with construction of homes.**
80. Section 17.98.130 requires that all parking and vehicular maneuvering areas shall be paved with asphalt or concrete. As required by Section 17.98.130, **all parking, driveway and maneuvering areas shall be constructed of asphalt, concrete, or other approved material.**
81. Section 17.98.200 contains requirements for providing on-street parking spaces for new residential development. Per Section 17.98.200, one on-street parking space at least 22 feet in length has been identified within 300 feet of each lot as required. Exhibit D, Sheet 10 shows that a minimum of 120 on-street parking spaces have been identified in compliance with this standard. No parking courts are proposed by the applicant.

17.100 – Land Division

82. Submittal of preliminary utility plans is solely to satisfy the requirements of Section 17.100.60. **Preliminary plat approval does not connote utility or public improvement plan approval which will be reviewed and approved separately upon submittal of public improvement construction plans.**

83. A pre-application conference was held with the City on February 1, 2021 per Section 17.100.60(A). The pre-app notes are attached as Exhibit S.
84. Section 17.100.60(E)(2) requires subdivisions to be consistent with the design standards set forth in this chapter. Consistency with design standards in this chapter are discussed under each subsection below. Conditions of approval can be adopted where necessary to bring the proposal into compliance with applicable standards.
85. Section 17.100.60(E)(3) requires the proposed street pattern to be connected and consistent with the Comprehensive Plan or official street plan for the City of Sandy. Given the requirements in Section 17.100.100(E), the site specific conditions of the subject property, particularly the location of the FSH overlay area, limits construction of an interconnected street system. The only existing street to be extended is Ortiz Street in Phase I, which is proposed to be located directly across Vista Loop Drive from the existing street. The applicant submitted a future street plan (Exhibit C, Sheet 10). As explained in Finding 94, the proposed street stub south of Bonnie Street will provide for additional street connectivity in the event that the Johnson RV site is redeveloped in the future. The street layout on the Johnson RV site is conceptual and not meant to imply that Johnson RV will be redeveloped as such. Also, the conceptual streets shown on the Johnson RV site would not all intersect with Highway 26 as detailed.
86. Section 17.100.60(E)(4) requires that adequate public facilities are available or can be provided to serve the proposed subdivision. All public utilities including water, sanitary sewer and stormwater are available or will be constructed by the applicant to serve the subdivision. The applicant shall meet this requirement as set forth in the conditions.
87. Section 17.100.60(E)(5) requires all proposed improvements to meet City standards through the completion of conditions as listed within this document and as detailed within these findings. The detailed review of proposed improvements is contained in this document.
88. Section 17.100.60(E)(6) strives to ensure that a phasing plan, if requested, can be carried out in a manner that meets the objectives of the above criteria and provides necessary public improvements for each phase as it develops. The applicant proposes building the subdivision in two phases: Phase I on the west side of Vista Loop Drive and Phase II on the east side of Vista Loop Drive.
89. Section 17.100.80 provides standards for denial of a development application due to physical land constraints. A significant portion of the Phase II is affected by the FSH overlay identified by the City of Sandy. The applicant does not propose any development within this area. A Geotechnical Evaluation (Exhibit F) for the property is included with the application package. Except for the areas designated as open space, all areas of Phase II and all of the Phase I property are suitable for development and do not pose any issues due to flooding.
90. As required by Section 17.100.100(A), a traffic impact study prepared in compliance with the City standards was submitted with the application (Exhibit H). Additional findings

related to the traffic impact study are located in the analysis of Chapter 17.84 in this document.

91. While Section 17.100.100(C) requires a rectangular grid pattern, but due to topographic constraints in the Lower Views and existing infrastructure in the Upper Views (the existing locations of Highway 26 and Vista Loop Drive) the site does not lend itself to creating a rectangular gridded street pattern.
92. Section 17.100.100(E) requires applicants to provide a future street plan within a 400 foot radius of the subject property(ies). Given the requirements in Section 17.100.100(E), the site specific conditions of the subject property, particularly the location of the FSH overlay area, limits construction of an interconnected street system.
93. Section 17.100.120(A) requires blocks to have sufficient width to provide for two tiers of lots at appropriate depths. However, exceptions to the block width shall be allowed for blocks that are adjacent to arterial streets or natural features. All blocks within the proposed subdivision have sufficient width to provide for two tiers of lots as required in Section 17.100.120(A), with the exception of blocks along Highway 26 and blocks adjacent to the FSH overlay district. The unique character of the site does not lend itself to creating blocks with two tiers due to the existing location of Highway 26 and the FSH overlay area.
94. Section 17.100.120(B) requires that blocks fronting local streets shall not exceed 400 feet in length. Several streets, Knapp Street in Phase I, and Barrett Street and Bonnie Street in Phase II, did not comply with the 400 foot block length standard, and the original application did not sufficiently explain why. After receiving an incompleteness letter from the City of Sandy, the applicant modified the land use application per Exhibit J to remove one lot (formerly Lot 84) to the south of Bonnie Street to meet the block length standard south of Bonnie Street and to explain how other blocks are constrained by topographical constraints and/or natural features.

Phase I: The south side of Knapp Street is longer than 400 feet but is limited for access due to access control rights on Highway 26. ODOT standards would not permit an additional access from Phase I to Highway 26. To alleviate pedestrian connection concerns, the applicant is being conditioned to locate two pedestrian connections from the cul-de-sacs in Ortiz Street and Knapp Street to the sidewalk along Highway 26, as explained in Finding 45.

Phase II: The proposed street stub south of Bonnie Street will provide for additional street connectivity in the event that the Johnson RV site is redeveloped in the future. The north side of Bonnie Street does not need to provide a street stub as the topographical constraints north of Lots 53 and 65 preclude street extension to the north. The west side of Barrett Street is detailed to include a street to the northwest in the general vicinity of Lot 38. Locating a street to the northeast of Lots 38 and 39 would be problematic due to existing topographical constraints, the stormwater tract, and wetlands. To alleviate pedestrian connection concerns, the applicant is being conditioned to locate a pedestrian connection from the cul-de-sac on Barrett Street to the northwest as explained in Finding 45.

95. As required by Section 17.100.130, eight-foot wide public utility easements will be included along all property lines abutting a public right-of-way. Eight foot wide public utility easements shall be included along all property lines abutting a public right-of-way. Staff does not believe that any other easements for public utility purposes are required but will verify this during construction plan review. **Preliminary plat approval does not connote utility or public improvement plan approval including easement locations which will be reviewed and approved separately upon submittal of public improvement construction plans.**
96. Section 17.100.150 outlines requirements for residential shared private drives. A shared private drive is intended to provide access to a maximum of two dwelling units. One of the following two criteria must be met: Direct access to a local street is not possible due to physical aspects of the site including size, shape, or natural features; or the construction of a local street is determined to be unnecessary. As shown on submitted plans the Phase II includes three private drives. These private drives are proposed due to the topographic constraints with the subject property. The design of the lots should be such that a shared access easement and maintenance agreement shall be established between the two units served by a shared private drive, public utility easements shall be provided where necessary in accordance with Section 17.100.130, and shared private drives shall be fully improved with an all weather surface (e.g. concrete, asphalt, permeable pavers) in conformance with city standards. The pavement width shall be 20 feet, and parking shall not be permitted along shared private drives at any time and shall be signed and identified accordingly. The proposed three private drives in Phase II are designed to serve only two lots each as permitted. **A shared access easement and maintenance agreement shall be established for each private drive as part of the Final Plat.** Public utility easements will be accommodated along these private drives as necessary to serve these lots. As shown on submitted plans each private drive is proposed to include a 20-foot wide all weather surface within a 21-foot wide tract and **shall be posted “no parking.”**
97. Section 17.100.180(A) requires that intersections are designed with right angles. All streets in the proposed subdivision have been designed to intersect at right angles to the opposing street as required.
98. All streets in the proposed subdivision have a minimum curve radius as required by Section 17.100.180(B).
99. **A lighting plan shall be coordinated with PGE and the City as part of the construction plan process and prior to installation of any fixtures as required by Section 17.100.210.**
100. All lots in the proposed subdivision have been designed so that no foreseeable difficulties due to topography or other conditions will exist in securing building permits on these lots as required by Section 17.100.220(A).
101. Section 17.100.220 states that all new lots shall have at least 20 feet of street frontage. All lots in the proposed subdivision contain at least 20 feet of frontage along a public street with the exception of the six lots that are proposed to be accessed by three private drives.

102. Only Lots 9 and 11-24 are designed to have frontage on both an internal local street (Knapp Street) and Highway 26. This configuration is unavoidable because of the location of Highway 26 and limitations for access to this roadway and is thus allowed as required by Section 17.100.220(D).
103. The applicant shall install all water lines and fire hydrants in compliance with the applicable standards in Section 17.100.230, which lists requirements for water facilities. **Water line sizes shall be based upon the Water Facilities Master Plan and shall be sized to accommodate domestic fire protection flows on the site.** The location of fire hydrants will be reviewed by the Sandy Fire Department in more detail with construction plans. **The applicant shall revise the Parking Analysis if required fire hydrants affect on-street parking spaces.**
104. The applicant intends to install sanitary sewer lines in compliance with applicable standards in Section 17.100.240. There is an existing septic system and drain fields for Johnson RV that are located on the property that is proposed to contain Phase II of Cedar Creek Heights. **The applicant shall decommission the existing septic system and drain fields, terminate the existing easements, and connect Johnson RV by means of a new sanitary sewer connection. Termination of the existing septic tank and connection of sanitary sewer will require a plumbing permit submitted to the Building Division and payment of applicable System Development Charges. Any on-site sewage disposal system shall be abandoned in conformance with Clackamas County Water Environmental Services (WES) regulations and a copy of the septic tank removal certificate shall be submitted to the City Planning Division.**
105. Section 17.100.250(A) details requirements for stormwater detention and treatment. Two stormwater detention facilities (Tracts B and F) are proposed to be located in the Lower Views and one facility (Tract A) is proposed in the Upper Views as shown in the submitted plan set. These facilities have been sized and located to accommodate public stormwater generated by the subdivision. A stormwater report (Exhibit G) is included with this application as required. Stormwater calculations are found to meet the water quality/quantity criteria as stated in the City of Sandy Development Code 13.18 Standards and the 2016 City of Portland Stormwater Management Manual Standards that were adopted by reference into the Sandy Development Code. **However, a detailed final report stamped by a licensed professional shall be submitted for review with the final construction plans.**
106. **The detention ponds shall be constructed to meet the requirements of the 2016 City of Portland Stormwater Management Manual for landscaping Section 2.4.1 and escape route Section 2.30. The access to the detention ponds shall be paved of an all-weather surface to a minimum of 12-foot in width per the 2016 City of Portland Stormwater Management Manual.**
107. Section 17.100.260 states that all subdivisions shall be required to install underground utilities. **The applicant shall install utilities underground with individual service to each lot.**

108. Grass seeding shall be completed as required by Section 17.100.300. The submitted erosion control plan (Exhibit D) provides additional details to address erosion control concerns. **A separate Grading and Erosion Control Permit will be required prior to any site grading.**
109. **All improvements listed in Section 17.100.300 shall be provided by the applicant including drainage facilities, monumentation, mail facilities, sanitary sewers, storm sewer, sidewalks, street lights, street signs, street trees, streets, traffic signs, underground communication lines including telephone and cable, underground power lines, water lines and fire hydrants.**

17.102 – Urban Forestry

110. Section 17.102.20 contains information on the applicability of Urban Forestry regulations. An Arborist Report by Todd Prager of Teragan & Associates (ASCA Registered Consulting Arborist #597, ISA Board Certified Master Arborist, WE-6723B, ISA Qualified Tree Risk Assessor) is included as Exhibit C. The arborist inventoried approximately 530 trees. The inventory is included in Exhibit C Sheet 6 and the proposed retention trees are shown in Exhibit C Sheet 7.
111. The property contains 32.87 acres requiring retention of 99 trees 11 inches and greater DBH ($32.87 \times 3 = 98.61$). The submitted Tree Retention Plan (Exhibit C Sheets 6 and 7) identifies 99 trees that will be retained. All 99 trees proposed for retention are 11 inches DBH or greater and in good condition as required.
112. No trees are proposed to be removed within the FSH overlay area. **The applicant shall not remove any trees from the restricted development area within the FSH overlay area.**
113. The Arborist Report (Exhibit D) provides recommendations for protection of retained trees including identification of the recommended tree protection zone for these trees. The requirements of Section 17.102.50(B) will be complied with prior to any grading or tree removal on the site. Per the Pacific Northwest International Society of Arboriculture (ISA), the ISA defines the critical root zone (CRZ) as “an area equal to a 1-foot radius from the base of the tree’s trunk for each 1 inch of the tree’s diameter at 4.5 feet above grade (referred to as diameter at breast height).” Often the drip-line is used to estimate a tree’s CRZ; however, it should be noted that a tree’s roots typically extend well beyond its drip-line. The submitted arborist report details a root protection zone radius of 1 foot per 1 inch DBH and a minimum construction setback radius of 0.5 feet per 1 inch DBH. **The applicant shall install tree protection fencing at the critical root zone of 1 foot per 1 inch DBH to protect the 99 retention trees on the subject property as well as all trees on adjacent properties. The tree protection fencing shall be 6 foot tall chain link or no-jump horse fencing and the applicant shall affix a laminated sign (minimum 8.5 inches by 11 inches) to the tree protection fencing indicating that the area behind the fence is a tree retention area and that the fence shall not be removed or relocated. No construction activity shall occur within the tree protection zone, including, but not limited to, dumping or storage of materials such as building supplies, soil, waste items, equipment, or parked vehicles. The applicant shall request an inspection of tree protection measures prior to any tree removal, grading, or other construction activity**

on the site. Up to 25 percent of the area between the minimum root protection zone of 0.5 feet per 1-inch DBH and the critical root zone of 1 foot per 1 inch DBH may be able to be impacted without compromising the tree, provided the work is monitored by a qualified arborist. The applicant shall retain an arborist on site to monitor any construction activity within the critical root protection zones of the retention trees or trees on adjacent properties that have critical root protection zones that would be impacted by development activity on the subject property. The applicant shall shift sediment fencing to outside the tree protection zones. If erosion control is required inside the tree protection zones, the applicant shall use straw wattles to minimize root zone disturbance of the trees to be retained. The applicant shall submit a post-construction report prepared by the project arborist or other TRAQ qualified arborist to ensure none of the retention trees were damaged during construction.

To ensure protection of the required retention trees, the applicant shall record a tree protection covenant specifying protection of all retention trees, including trees in the FSH Overlay per the recommendations of the applicant's arborist report of 1 foot per 1 inch DBH. The tree protection covenant shall specify limiting removal of the retention trees without submittal of an Arborist's Report and City approval. This document shall include a sketch identifying the required retention trees and a 1 foot per 1 inch DBH radius critical root zone around each tree consistent with the applicant's arborist report. All trees marked for retention shall be retained and protected during construction regardless of desired or proposed building plans; plans for future houses on the proposed lots within the subdivision shall be modified to not encroach on retention trees and associated tree protection fencing.

- 114. The applicant shall adhere to the regulations of the Migratory Bird Act. If trees are removed during prime nesting season (February 1- July 31), the applicant shall check for nests prior to tree removal. If nests are discovered, the applicant shall delay tree removal until after the nesting season or shall hire a professional to relocate the nests to an appropriate nearby location, provided the species using the nest is not invasive.**
- 115. The arborist report contains additional recommendations related to tree protection, directional felling, stump removal, tree crown protection, monitoring of new grove edges, and sediment fencing. The applicant shall follow the recommendations outlined in the arborist report related to tree protection, directional felling, stump removal, tree crown protection, monitoring of new grove edges, and sediment fencing.**

15.30 – Dark Sky

- 116. Chapter 15.30 contains the City of Sandy's Dark Sky Ordinance. The applicant will need to install street lights along all street frontages wherever street lighting is determined necessary. The locations of these fixtures shall be reviewed in detail with construction plans. Full cut-off lighting shall be required. Lights shall not exceed 4,125 Kelvins or 591 nanometers in order to minimize negative impacts on wildlife and human health.**

15.44 – Erosion Control

- 117. The applicant submitted a Geotechnical Report (Exhibit F) prepared by Redmond Geotechnical Services dated May 15, 2020. The applicant shall retain appropriate**

professional geotechnical services for observation of construction of earthwork and grading activities. The grading setbacks, drainage, and terracing shall comply with the Oregon Structural Specialty Code (OSSC) requirements and the geotechnical report recommendations and conclusions as indicated in the report. When the grading is completed, the applicant shall submit a final report by the Geotechnical Engineer to the City stating that adequate inspections and testing have been performed on the lots and all of the work is in compliance with the above noted report and the OSSC. Site grading should not in any way impede, impound or inundate the adjoining properties.

118. All the work within the public right-of-way and within the paved area should comply with American Public Works Association (APWA) and City requirements as amended. The applicant shall submit a grading and erosion control permit and request an inspection of installed devices prior to any additional grading onsite. The grading and erosion control plan shall include a re-vegetation plan for all areas disturbed during construction of the subdivision. All erosion control and grading shall comply with Section 15.44 of the Municipal Code. The proposed subdivision is greater than one acre which requires approval of a DEQ 1200-C Permit.

119. Section 15.44.50 contains requirements for maintenance of a site including re-vegetation of all graded areas. The applicant's Erosion Control Plan shall be designed in accordance with the standards of Section 15.44.50.

120. Development at both the Zion Meadows subdivision and the remodel of the Pioneer Building (former Sandy High School) have sparked unintended rodent issues in the surrounding neighborhoods. Prior to development of the site, the applicant shall have a licensed pest control agent evaluate the site to determine if pest eradication is needed.

DECISION

For the reasons described above, the request by Even Better Homes to construct an 89-lot subdivision is hereby **approved** with the following conditions.

CONDITIONS OF APPROVAL

A. Prior to earthwork, grading, or excavation, the applicant shall complete the following and receive necessary approvals as described:

- 1. Obtain a grading and erosion control permit in conformance with Chapter 15.44. The grading and erosion control plan shall include a re-vegetation plan for all areas disturbed during construction of the subdivision. (*Submit 2 copies to the Building Division*)**
- 2. Shift sediment fencing to outside the tree protection zones. If erosion control is required inside the tree protection zones, the applicant shall use straw wattles to minimize root zone disturbance of the trees to be retained.**

3. **Submit proof of receipt of a Department of Environmental Quality 1200-C permit.
(Submit 2 copies to the Building Division)**
4. **Any existing domestic or irrigation wells on site shall be located, identified, capped, disconnected or abandoned in conformance with OAR 690-220-0030. A copy of the Oregon Water Resources Department (OWRD) abandonment certificate shall be submitted to the City Planning Division.**
5. **Decommission the existing septic system and drain fields, terminate the existing easements, and connect Johnson RV by means of a new sanitary sewer connection. Termination of the existing septic tank and connection of sanitary sewer will require a plumbing permit submitted to the Building Division and payment of applicable System Development Charges. Any on-site sewage disposal system shall be abandoned in conformance with Clackamas County Water Environmental Services (WES) regulations and a copy of the septic tank removal certificate shall be submitted to the City Planning Division.**
6. **Install tree protection fencing at the critical root zone of 1 foot per 1 inch DBH to protect the 99 retention trees on the subject property as well as all trees on adjacent properties. The tree protection fencing shall be 6 foot tall chain link or no-jump horse fencing and the applicant shall affix a laminated sign (minimum 8.5 inches by 11 inches) to the tree protection fencing indicating that the area behind the fence is a tree retention area and that the fence shall not be removed or relocated. No construction activity shall occur within the tree protection zone, including, but not limited to, dumping or storage of materials such as building supplies, soil, waste items, equipment, or parked vehicles. The applicant shall request an inspection of tree protection measures prior to any tree removal, grading, or other construction activity on the site. Up to 25 percent of the area between the minimum root protection zone of 0.5 feet per 1-inch DBH and the critical root zone of 1 foot per 1 inch DBH may be able to be impacted without compromising the tree, provided the work is monitored by a qualified arborist. The applicant shall retain an arborist on site to monitor any construction activity within the critical root protection zones of the retention trees or trees on adjacent properties that have critical root protection zones that would be impacted by development activity on the subject property. The applicant shall submit a post-construction report prepared by the project arborist or other TRAQ qualified arborist to ensure none of the retention trees were damaged during construction.**
7. **Install tree protection fencing at the outer edge of the restricted development area within the FSH overlay district prior to grading.**
8. **Follow the recommendations outlined in the arborist report related to tree protection, directional felling, stump removal, tree crown protection, monitoring of new grove edges, and sediment fencing.**
9. **Request an inspection of erosion control measures and tree protection measures as specified in Section 17.102.50(C). Receive an approval of erosion control measures and tree protection measures prior to grading activities.**

10. Submit confirmation from a licensed pest control agent that the site was reviewed to determine if pest eradication is needed.
11. Adhere to the regulations of the Migratory Bird Act. If trees are removed during prime nesting season (February 1- July 31), the applicant shall check for nests prior to tree removal. If nests are discovered, the applicant shall delay tree removal until after the nesting season or shall hire a professional to relocate the nests to an appropriate nearby location, provided the species using the nest is not invasive.

B. Prior to all construction activities, except grading and/or excavation, the applicant shall submit the following additional information as part of construction plans and complete items during construction as identified below:

1. The location of fire hydrants shall be reviewed by the Sandy Fire Department in more detail with construction plans. Revise the Parking Analysis if required fire hydrants affect on-street parking spaces.
2. Submit additional details on street trees spaced approximately 30 feet apart on center. The street tree species shall be selected from the City of Sandy street tree list; due to concerns with Asian Longhorn Beetle and Emerald Ash Borer, staff are not approving maples or ashes as street trees at this time. To improve species diversity, the applicant shall include at least four (4) different tree species, with at least two (2) different species per street.
3. Submit a profile design for a minimum of 200 feet for all future street extensions beyond the project boundary to ensure future street grades can be met.
4. Submit details showing that the sum of the width of all driveway approaches within the bulb of each cul-de-sac as measured in Section 17.98.100(B) does not exceed fifty percent of the circumference of the cul-de-sac bulb.
5. Submit details on additional pedestrian connections from the Ortiz Street cul-de-sac to Highway 26 and from the Knapp Street cul-de-sac to both Vista Loop Drive and Highway 26. The pedestrian connections from the Knapp Street cul-de-sac to Highway 26 and Vista Loop Drive may be located in a 15 foot wide easement. All three pedestrian connections shall consist of an 8 foot wide paved pathway, bollard lighting, and shall include vegetation.
6. Submit details on a pedestrian connection from the Barrett Street cul-de-sac to tax lot 25E1900401. The pedestrian connection from the Barrett Street cul-de-sac to tax lot 25E1900401 may be located in a 15 foot wide easement, but not located in Tract J. This pedestrian connection shall consist of an 8 foot wide paved pathway, bollard lighting, and shall include vegetation.

7. Submit details on the locations of street lights on all streets being improved within and adjacent to the subdivision. Full cut-off lighting shall be required that does not exceed 4,125 Kelvins.
8. Submit a detailed final stormwater report stamped by a licensed professional to the City for review and approval.
9. Demonstrate that the proposed subdivision does not exceed pre-development site runoff discharges to this same point and provide information on the dimensions and slope of the existing drainage way. The detention ponds shall meet the requirements of the 2016 City of Portland Stormwater Management Manual (SWMM) for landscaping, Section 2.4.1, and escape route, Section 2.30.
10. Submit a mail delivery plan, featuring grouped lockable mail facilities, to the City and the USPS for review and approval prior to installation of mailboxes. Mail delivery facilities shall be provided by the applicant in conformance with Section 17.84.100 and the standards of the USPS. Phase I and Phase II shall each have their own mail facility to reduce unnecessary vehicular trips to retrieve mail.
11. Revise the utility plan to include broadband fiber locations as detailed by the SandyNet Manager.

C. Prior to Final Plat approval, the applicant shall complete the following tasks or provide assurance for their future completion:

1. Pay plan review, inspection, and permit fees as determined by the Public Works Director, and install all public improvements.
2. Plant street trees along the public stormwater tracts.
3. When the grading is completed, the applicant shall submit a final report by the Geotechnical Engineer to the City stating that adequate inspections and testing have been performed on all lots and all of the work is in compliance with the above noted report and OSSC.
4. The City of Sandy reserves the right to name streets. The applicant and City staff shall identify new street names prior to final plat.
5. Dedicate the 0.30 acres of parkland on a form approved by the City. The active parkland shall not exceed an average slope of 15 percent.
6. Record a blanket pedestrian easement over the entirety of Tract D.
7. Pay a parks fee in-lieu for the remaining 0.85 acres, or up to 2.00 acres if all lots are developed with duplexes. The fee in-lieu shall be \$204,850 (\$241,000 multiplied by 0.85 acres) if paid prior to recording of final plat, or \$225,250 (\$265,000 multiplied by 0.85 acres) if half is deferred to building permit issuance. If the applicant chooses to defer

payment, the applicant shall pay \$112,625 prior to recording of final plat and the additional \$112,625 divided by the 89 lots, or \$1,265.45 with each building permit.

8. Record a tree protection covenant specifying protection of the 99 trees on the subject property and limiting removal without submittal of an Arborist's Report and City approval. This document shall include a sketch identifying the required retention trees and a 1 foot per 1 inch DBH radius critical root zone around each tree. All trees marked for retention shall be retained and protected during construction regardless of desired or proposed building plans; plans for future houses on the proposed lots within the subdivision shall be modified to not encroach on retention trees and associated tree protection fencing.
9. Complete all street improvements (including sidewalks) adjacent to the parkland tract at the applicant's expense.
10. Post each private drive with 'no parking' signs.
11. Grade the active parkland tract of 0.30 acres to accommodate playground equipment and seed the parkland with a seed mix as specified during construction plan review.
12. Install a concrete bus shelter pad and a green bench (Fairweather model PL-3, powder-coated RAL6028). The required pad size is 7 feet by 9.5 feet and should be located at the northernmost corner of Barrett Street and Vista Loop Drive. Engineering specifications are available from the Transit Department.
13. Submit an updated Geotech Report or submit an addendum to the Geotech Report that provides analysis of the new stormwater discharge.
14. In order to better protect newly planted trees, the applicant shall amend and aerate the soil within the planter strip 15 feet in both directions from where the tree will be planted (or as is feasible based on locations of driveways or street corners). Submit documentation from the project landscaper stating that the soil has been amended and aerated prior to planting the street trees.
15. If the applicant chooses to postpone street tree and/or landscaping installation, the applicant shall post a performance bond equal to 120 percent of the cost of the street trees/landscaping, assuring installation within 6 months. The cost of the street trees shall be based on the average of three estimates from three landscaping contractors; the estimates shall include as separate items all materials, labor, and other costs of the required action, including a two-year maintenance and warranty period.
16. Pay addressing fees for the subdivision as identified in the most updated fee schedule.
17. Submit a true and exact reproducible copy (Mylar) of the Final Plat for final review and signature.
18. Submit a copy of the following once recorded:

- Tree protection covenant including a map identifying the location of the retention trees.
- A shared access easement and maintenance agreement for each private drive.
- Deeds identifying dedications to the City.

D. The following list includes conditions related to individual lot construction:

1. No building permits, except for one model home, will be issued until all public utilities including sanitary sewer and water service are available to serve the development and the City determines substantial completion of all public improvements. If the applicant chooses to install a model home, the applicant shall commit to a Model Home Agreement with the City of Sandy.
2. All homes shall provide building design features in conformance with the standards of Section 17.90.150.
3. All homes shall meet the development standards of Section 17.34.30.
4. If any lot includes a duplex, the applicant shall pay an additional \$3,114.00 (1.15 multiplied by \$241,000 divided by 89) with the building permit for that lot.
5. If any lot includes a duplex, the applicant shall pay addressing fees as identified in the most updated fee schedule.
6. Street trees shall be installed approximately 30 feet on center in conjunction with issuance of building permits. Street trees are required to be a minimum caliper of 1.5-inches measured 6 inches from grade. Trees shall be planted and staked per the City of Sandy standard planting detail; trees shall be tied to the stakes with loosely tied twine. Tree ties shall be removed within one year of installation.
7. All planter strips shall be graded and backfilled as necessary, and bark mulch, vegetation, or other approved material installed prior to occupancy.
8. All trees marked for retention shall be retained and protected during construction regardless of desired or proposed building plans. Plans for future houses on the proposed lots within the subdivision shall be modified to not encroach on retention trees and associated tree protection fencing.
9. Development of this subdivision shall require payment of system development charges in accordance with applicable City ordinances.
10. Locate all structures a minimum of 20 feet from the property lines along Vista Loop Drive and Highway 26.
11. Orient the homes on lots 9 and 11-24 toward Highway 26 with pedestrian connections to the street. The pedestrian route shall consist of materials such as concrete, asphalt, stone, brick, permeable pavers, or other materials as approved by the Director. The pedestrian

path shall be permanently affixed to the ground with gravel subsurface or a comparable subsurface as approved by the Director.

12. Orient the homes on lots 26-27 and 35-37 toward Vista Loop Drive with pedestrian connections to the street. The pedestrian route shall consist of materials such as concrete, asphalt, stone, brick, permeable pavers, or other materials as approved by the Director. The pedestrian path shall be permanently affixed to the ground with gravel subsurface or a comparable subsurface as approved by the Director.
13. Lot 25 shall either orient to Vista Loop Drive or Highway 26 or have a door that faces the intersection of the two subject streets. If a duplex is proposed on Lot 25 one front door may face Vista Loop Drive and the second front door may face Highway 26.
14. Design the houses on Lots 67 and 68 to include at least ten (10) percent windows, at least two siding types, and a minimum of three additional design features from Section 17.90.150 facing the parkland tract.
15. The fences along Lots 9, 11-27, and 35-37 shall not exceed four (4) feet in height along their respective transit streets.
16. Garages shall be at least 18 feet in depth to accommodate vehicle parking and the on-street parking spaces shall be at least 22 feet in length. All parking, driveway and maneuvering areas shall be constructed of asphalt, concrete, or other approved material.
17. Driveway approach width for a single-family dwelling shall be at least 10 feet and the maximum driveway approach within the public right-of-way shall be 24 feet wide measured at the bottom of the curb transition. Driveways shall taper to match the driveway approach width to prevent stormwater sheet flow from traversing sidewalks.

E. The following list includes conditions related to FSH review:

1. A violation of the provisions set forth in Chapter 17.60, FSH, (e.g. tree removal without permit authorization or native vegetation removal) may result in a fine as specified in Section 17.06.80.
2. Do not remove any living or dead trees or vegetation that is hazardous to the public from the FSH area without applying for an FSH review for their removal.
3. Do not perform any grading activities or cut or fill in the FSH overlay area without applying for an FSH review for the grading/cut and fill.
4. Do not remove any native vegetation from the FSH overlay area. Do not plant any non-native vegetation in the FSH overlay area.
5. Do not install any impervious surfaces within the restricted development area.

6. The applicant shall not damage or remove any native vegetation within the FSH overlay district. The applicant shall replace any disturbed understory or groundcover with native understory or groundcover species that effectively cover the disturbed area. The applicant shall retain a qualified arborist on-site for any work done within the critical root zone (1 foot per 1 inch DBH) of retention trees including those within the FSH area to ensure minimum impact to trees and native vegetation.

F. General Conditions of Approval:

1. The Final Plat shall be recorded as detailed in Section 17.100.60.
2. Public improvement plans are subject to a separate review and approval process. Preliminary Plat approval does not connote approval of public improvement construction plans, which will be reviewed and approved separately upon submittal of public improvement construction plans.
3. An ODOT Permit to Occupy or Perform Operations Upon a State Highway shall be obtained for all work in the State highway right-of-way.
4. Improvements adjacent to the site's Highway 26 frontage shall consist of a six-foot wide sidewalk constructed at the top of the bank, lighting, and street trees only as approved and permitted by ODOT.
5. The vertical design grade for landing at all the Tee intersections where controlled with "Stop" signs shall be no greater than 8 percent for a minimum of 50 feet or two car lengths.
6. The developer and/or lot owners shall maintain all vegetation planted in the development for two years unless otherwise noted and shall replace any dead or dying plants during that period.
7. If entry signs are desired, the applicant shall submit a detailed plan showing the location of such signage and a sign permit application.
8. All work within the public right-of-way and within the paved area shall comply with the American Public Works Association (APWA) and City requirements as amended.
9. All ADA ramps shall be designed, inspected by the design engineer, and constructed by the contractor to meet the most current PROWAG requirements.
10. All on-site earthwork activities including any retaining wall construction shall follow the current requirements of the current edition of the Oregon Structural Specialty Code (OSSC). If the proposal includes a retaining wall, the applicant shall submit additional details on the proposed retaining wall for staff review and approval. Retaining walls may include building permit submission to the Building Division.

11. All franchise utilities shall be installed underground and in conformance with City standards with individual service to each lot.
12. The applicant shall be responsible for the installation of all improvements detailed in Section 17.100.310, including fiber facilities. SandyNet requires the developer to work with the City to ensure that broadband infrastructure meets the design standards and adopted procedures as described in Section 17.84.70.
13. All public utility installations shall conform to the City's facilities master plans.
14. Site grading shall not in any way impede, impound, or inundate the surface drainage flow from the adjoining properties.
15. The applicant shall retain appropriate professional geotechnical services for observation of construction of earthwork and grading activities. The grading setbacks, drainage, and terracing shall comply with the Oregon Structural Specialty Code (OSSC) requirements and the geotechnical report recommendations and conclusions as indicated in the report.
16. Water line sizes shall be based upon the Water Facilities Master Plan and shall be sized to accommodate domestic fire protection flows on the site.
17. All public sanitary sewer and waterline mains shall be a minimum of 8 inches in diameter and shall be extended to the plat boundaries where practical to provide future connections to adjoining properties.
18. All stormwater drains shall be a minimum of 12 inches in diameter and shall be extended to the plat boundaries where practical to provide future connections to adjoining properties.
19. As required by Section 17.92.10(L), all landscaping shall be continually maintained, including necessary watering, weeding, pruning, and replacing. As required by Section 17.92.140, the developer shall maintain all vegetation planted in the development for two (2) years from the date of completion, and shall replace any dead or dying plants during that period.
20. Exposed soils shall be covered by mulch, sheeting, temporary seeding or other suitable material following grading or construction to maintain erosion control for a period of two years following the date of recording of the final plat associated with those improvements.
21. Successors-in-interest of the applicant shall comply with site development requirements prior to the issuance of building permits.
22. All improvements listed in Section 17.100.300 shall be provided by the applicant including drainage facilities, monumentation, mail facilities, sanitary sewers, storm sewer, sidewalks, street lights, street signs, street trees, streets, traffic signs, underground

communication lines including telephone and cable, underground power lines, water lines and fire hydrants.

23. Comply with all standards required by Section 17.84 of the Sandy Development Code. Public and franchise improvements shall be installed or financially guaranteed in accordance with Chapter 17 of the Sandy Municipal Code prior to temporary or final occupancy of structures. Water lines and fire hydrants shall be installed in accordance with City standards. All sanitary sewer lines shall be installed in accordance with City standards.
24. Comply with all other conditions or regulations imposed by the Sandy Fire District or state and federal agencies. Compliance is made a part of this approval and any violations of these conditions and/or regulations may result in the review of this approval and/or revocation of approval.

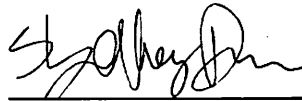

Shelley Denison
Associate Planner

RIGHT OF APPEAL

A decision on a land use proposal or permit may be appealed to the Planning Commission by an affected party by filing an appeal with the Director within 12 calendar days of notice of the decision. Any person interested in filing an appeal should contact the city to obtain the form, "Notice of Appeal", and Chapter 17.28 of the Sandy Development Code regulating appeals. All applications for an appeal shall indicate the nature of the interpretation that is being appealed and the matter at issue will be a determination of the appropriateness of the interpretation of the requirements of the Code.

An application for an appeal shall contain:

1. An identification of the decision sought to be reviewed, including the date of the decision;
2. A statement of the interest of the person seeking review and that he/she was a party to the initial proceedings;
3. The specific grounds relied upon for review;
4. If de novo review or review by additional testimony and other evidence is requested, a statement relating the request to the factors listed in Chapter 17.28.50; and,
5. Payment of required filing fees.