

WETLAND DELINEATION / DETERMINATION REPORT COVER FORM Exhibit I

This form must be included with any wetland delineation report submitted to the Department of State Lands for review and approval. A wetland delineation report submittal is not "complete" unless the fully completed and signed report cover form and the required fee are submitted. Attach this form to the front of an unbound report or include a hard copy of the completed form with a CD/DVD that includes a single PDF file of the report cover form and report (minimum 300 dpi resolution) and submit to: **Oregon Department of State Lands, 775 Summer Street NE, Suite 100, Salem, OR 97301-1279**. A single PDF attachment of the completed cover form and report may be e-mailed to **Wetland_Delineation@dsl.state.or.us**. For submittal of PDF files larger than 10 MB, e-mail instructions on how to access the file from your ftp or other file sharing website. Fees can be paid by check or credit card. Make the check payable to the Oregon Department of State Lands. To pay the fee by credit card, call 503-986-5200.

<input checked="" type="checkbox"/> Applicant <input type="checkbox"/> Owner Name, Firm and Address: Rosemont Development 10117 SE Sunnyside Road Clackamas, Oregon, 97015	Business phone # 503-351-4747 Mobile phone # _____ E-mail: rosemontdevelopment@gmail.com
--	--

<input checked="" type="checkbox"/> Authorized Legal Agent, Name and Address: Environmental Technology Consultants 375 Portland Ave, Gladstone, OR 97027	Business phone # 360-696-4403 Mobile phone # 360-984-8767 E-mail: AnnakateM@etcEnvironmental.net
--	--

I either own the property described below or I have legal authority to allow access to the property. I authorize the Department to access the property for the purpose of confirming the information in the report, after prior notification to the primary contact.
 Typed/Printed Name: Annakate Martin Signature: Annakate Martin
 Date: **August 2020** Special instructions regarding site access: **Contact owner or consultant.**

Project and Site Information (using decimal degree format for lat/long of site or start & end points of linear project)

Project Name: 37090 SE Kelso Road	Latitude: N 45.417907	Longitude: W -122.2831
Proposed Use: SUBDIVISION, SINGLE FAMILY HOMES	Tax Map # 24E11 Lot 24E11 02204 Parcel Number 05034843	
Project Street Address (or other descriptive location): No Situs Address (Formally known as 37090 SE Kelso Road)	Township T2S Range R4E Section 11 QQ Tax Lot(s) 24E1102204	
City: Sandy, OR County: Clackamas	Waterway: No name River Mile: _____ NWI Quad(s): Sandy, Oregon	

Wetland Delineation Information

Wetland Consultant Name, Firm and Address: John McConnaughey, PWS & Annakate Martin NRS Environmental Technology Consultants 375 Portland Ave, Gladstone, OR 97027	Phone # 360-696-4403 Mobile phone # 360-984-8767 E-mail: AnnakateM@etcEnvironmental.net JohnM@etcEnvironmental.net
The information and conclusions on this form and in the attached report are true and correct to the best of my knowledge. Consultant Signature: <u>Annakate Martin</u> Date: May, 2017 updated April 2020	

Primary Contact for report review and site access is Consultant Applicant/Owner Authorized Agent

Wetland/Waters Present? Yes No Study Area size: **2.69 acres** Total Wetland Acreage: **1.69 AC**

Check Box Below if Applicable: Fees: \$466 (2020)

<input type="checkbox"/> R-F permit application <input type="checkbox"/> Mitigation bank site <input type="checkbox"/> Wetland restoration/enhancement project (not mitigation) <input type="checkbox"/> Industrial Land Certification Program Site <input type="checkbox"/> Reissuance of a recently expired delineation Previous DSL # _____ Expiration date _____	<input checked="" type="checkbox"/> Fee payment submitted \$466 <input type="checkbox"/> Fee (\$100) for resubmittal of rejected report <input type="checkbox"/> No fee for request for reissuance of an expired report
---	--

Other Information:

Has previous delineation/application been made on parcel?	Y	N	
	<input checked="" type="checkbox"/>	<input type="checkbox"/>	If known, previous WD2018-0656
Does LWI, if any, show wetland or waters on parcel?	<input type="checkbox"/>	<input checked="" type="checkbox"/>	

For Office Use Only

DSL Reviewer: _____	Fee Paid Date: ____ / ____ / ____	DSL WD # _____
Date Delineation Received: ____ / ____ / ____	DSL Project # _____	DSL Site # _____
Scanned: <input type="checkbox"/> Final Scan: <input type="checkbox"/>	DSL WN # _____	DSL App. # _____

WETLAND DELINEATION REPORT
Tax Lot 24E11 02204
Formally 37090 SE Kelso Road
Sandy, OR



Evaluated by:
Annakate Martin, NRS
John McConnaughey PWS# 2009
May, 2017 and August 2020

Annakate Martin

Prepared for: Rosemont Development
Rob Venema
10117 SE Sunnyside Road
Clackamas, OR 97015

 <p>Environmental technology Consultants</p>	<p>Environmental Technology Consultants <i>A Division of Sisul Enterprises, Inc.</i> 375 Portland Ave, Gladstone, OR 97027 PO Box 821185, Vancouver, WA 98682 (360) 696-4403 Fax: (503) 657-5779 WA Landscape Contractors License #: ENVIRTCO23RB Web: www.etcEnvironmental.net Email: etc@etcEnvironmental.net</p>
<p><i>"Creating Tomorrow's Environment - Today"</i></p>	

Table of Contents

Cover Photo.....	3
INTRODUCTION.....	4
QUALIFICATIONS OF JOHN MCCONNAUGHEY, PWS.....	5
QUALIFICATIONS OF ANNAKATE MARTIN.....	5
A) Landscape Setting and Land Use:.....	5
B) Site Alterations:.....	6
C) Precipitation Data and Analysis:.....	6
D) Methods: (site-specific methods for field investigation).....	6
E) Description of All Wetlands and Other Non-Wetland Waters:	7
F) Deviation from LWI or NWI:.....	7
G) Mapping Method:.....	7
H) Additional Information: (i.e., if needed to establish state jurisdiction).....	7
I) Results and Conclusions:.....	7
Disclaimer: OAR141-090-0035(12)(j) :.....	8
APPENDIX A - Maps:.....	9
APPENDIX B - Data Forms.....	10
APPENDIX C - Ground Level Color Photographs:.....	11
APPENDIX D - Sensitive Area Certification:.....	13

Cover Photo.

Photo of Wetland A shortly after blackberries were mowed, looking west at the first wetland investigation.
ETC Photo 3/13/2017

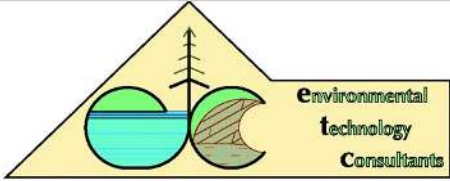
INTRODUCTION

This report delineates the wetlands and waterways of lot 24E11 02204. There used to be a house on this lot with the address of 37090 SE Kelso Road, Sandy Oregon. The house and address no longer exist. Lot 2204 is the northern portion of a larger piece of property known as lot 2200 that was subdivided in the process of building the Sandy Woods subdivision.

Originally ETC prepared a delineation report covering the entire lot 2200 (37090 SE Kelso Road). The applicant then decided only to develop the southern portion of the property and requested that ETC remove the North portion of the property from the study area. Accordingly, ETC authored and submitted a report for areas South of the BPA powerline ROW which bisected lot 2200. That delineation was numbered WD2017-0410 and was concurred with by DSL for Joe Spaziani.

In the process of permitting the Sandy Woods subdivision, the City of Sandy required the applicant to widen Olson Road, and this necessitated fills to a wetland area known as Track "A" and Track "E". DSL also required the applicant to delineate the remainder of the property due to the usage of an access road coming in from Kelso Road. Accordingly, ETC authored and submitted a report numbered WD2018-0656 that included the remainder of lot 2200 and Tracks "A" and "E". In the course of reviewing WD2018-0656, DSL determined that there may be errors in the wetland boundary plots that defined what we are calling Wetland "A" of lot 2200, (not to be confused the wetland in Track "A" next to Olson Road). Because the project at that time did not impact Wetland "A", we elected to remove the area from the study boundary of WD2018-0656. The report was subsequently concurred with by DSL.

The applicant sold the property to Rosemont development and now is planning a subdivision development for the areas North of the BPA Powerline on lots 2204 and 2202. Lot 2203 is a conservation track for a stream and small wetland. Lots 2202 and 2203 were included in WD2018-0656.

The study area of WD2018-0656 included the upland portions of lot 2204, which included the former house and some farmed areas.

In conversations with DSL, ETC requested guidance on defining the study boundary for this report. We requested that it include the entire lot 2204 in order to make a clean report with a study boundary defined by lot lines. DSL disagreed and instructed ETC to include only those portions of lot 2204 that were not previously delineated by WD2018-0656. This is the reason the study boundary in this report bisects lot 2204 close to the Wetland "A" boundary.

Lot 2205 is a sliver of land between the old western boundary of the original lot 2200, and a fence separating lot 2200 and lot 2300. Rather than move the fence or argue with the owner of lot 2300 over this land, the applicant has deeded lot 2205 to the owner of lot 2300. For this reason, lot 2205 is not included in any of the delineation studies mentioned in this report.

The ditches of Kelso Road that are in the Kelso Road ROW are not included in this report. Water from these ditches is the primary source of water that creates wetland "A".

Study Area: This report includes only those portions of lot 2204 not previously delineated by WD2018-0656, basically an area containing a sloped wetland area we are calling Wetland "A". Some of the field work was done in 2017 and revisited in 2020 for this report.

The relevant previously submitted delineations and reports for the original lot 2200 and Tracks "A" and "E" are:

- WD2017-0410 - The south portions of the parent parcel Tax Lot 2200 (37090 SE Kelso Road), which has since been subdivided. The wetland study included the entire tax lot 2200, however in the process of developing the subdivision submittals the applicant decided to remove the North half of lot 2200 from the study boundary.

- WD2018-0656- This report included northern portions of tax lot 2200 (except Wetland “A”). The reason for removing Wetland “A” from the study boundary is discussed above.

The timing of site visits and writing of this report was affected by shutdowns in response to the COVID-19 pandemic. The shutdowns delayed the production of this report.

This report is intended to assist the permittee, the City of Sandy, and the State of Oregon to evaluate the application and determine what environmental conditions or mitigations may be required to move this project forward.

QUALIFICATIONS OF JOHN MCCONNAUGHEY, PWS

I earned a Bachelor of Science degree from the University of Oregon in 1978 and in 1984 I earned a Masters of Fisheries Science degree from the University of Alaska at Juneau, (since renamed as the University of Alaska, Southeast). The Juneau curriculum specializes in the study of Pacific salmon. I held positions with agencies tasked with salmon research and management beginning with summer jobs in 1979 in Rogue River, the Oregon Dept of Fish and Wildlife, and then with the Alaska Department of Fish and Game in Ketchikan Alaska, in 1980. I worked on salmon projects with ADF&G in Anchorage and Juneau for 5 years before moving to American Samoa to serve as a fisheries project's leader for the Department of Marine and Wildlife Resources. Upon returning stateside, I worked for the Yakama/Klickitat Fisheries Project out of Yakima Washington for 5 years leading four research projects studying aspects of salmon supplementation projects in the Yakima River.

I have been employed with Environmental Technology Consultants since 2006. In 2010 I earned certification as a Professional Wetland Scientists, (PWS) from the Society of Wetlands Scientists, (SWS).

No part of my compensation is dependent on the outcome of my investigations or conclusions I may draw from the observed data.

QUALIFICATIONS OF ANNAKATE MARTIN

I earned a Bachelor of Science degree in Natural Resources from Washington State University in 2002. In 2002 I worked for the University of Idaho on MAP tracking steelhead and salmon on the Snake River out of Clarkston, Washington. 2002-2003 I worked for Idaho Fish and Game as a field technician for identifying fish in remote streams in Idaho. In 2004 I worked for Environmental Technology Consultants conducting wetland delineations and Phase I ESA reports. From 2007-2014 I worked for 3 Kings Environmental conducting Phase I ESA reports, asbestos and lead surveys. In 2011 I started my own company primarily providing erosion control services (CESCL Certified) and Phase I ESA reports. I worked for Clark Public Utilities as a Restoration Specialist Supervisor and decided to return to ETC.

I have been re-employed with Environmental Technology Consultants in 2015 for wetland delineation consulting.

A) Landscape Setting and Land Use:

The subject property is a 11.88 Acre parcel in a rural residential area. that is on a hillslope at approximately 787' in elevation. It is in the Clackamas River watershed. The terrain is gently rolling in the general north to south direction on the majority of the property. The property is surrounded primarily by agricultural land, and partially by roads, rural single-family residences, and single-family residences in subdivisions. The property was a sloped area that had a 100% cover of Himalayan Blackberry.

The area is zoned SFR.

B) Site Alterations:

The subject site had a single-family residence, that has been demolished, and according to the Assessors information was built in 1915. Portions of the property have been used for agriculture uses such as a plant nursery, and possibly a raspberry farm. In 2017 the applicant used a brush hog to mow the blackberries on most of the site in order that surveyors could gain access. Much of the property that was historically farmed now has a dense cover of blackberries. The property was divided up into different tax lots in 2019, the portion containing Wetland "A" is now tax lot 2204 and 11.88 acres in size. The site was revisited April 15,2020 to re-delineate Wetland "A".

C) Precipitation Data and Analysis:

This wet season was above average in January 2020, but below average in February and March. The table below shows the precipitation from the WETS table:

WETS Station: PORTLAND INTL AIRPORT, OR	Observed Precip				Avg Precip 1971- 2000	30% chance precip less than	30% chance precip more than	Observed Compared to WETS Average		
	2017	2018	2019	2020				2018	2019	2020
Jan		5.36	2.79	9.83	5.07	2.98	6.15	Avg	Below	Above
Feb		1.86	4.10	2.45	4.18	2.84	4.98	Below	Avg	Below
Mar		2.50	1.54	2.75	3.71	2.85	4.31	Below	Below	Below
Apr		3.34	2.98		2.64	1.93	3.10	Above	Avg	
May		0.17	1.51		2.38	1.44	2.88	Below	Avg	
Jun		1.03	0.45		1.59	0.94	1.93	Avg	Below	
Jul		0.02	0.80		0.72	0.33	0.86	Below	Avg	
Aug		0.06	1.23		0.93	0.35	1.09	Below	Above	
Sep		1.59	3.85		1.65	0.72	1.93	Avg	Above	
Oct		3.43	1.51		2.88	1.57	3.52	Avg	Below	
Nov		2.86	1.52		5.61	3.72	6.73	Below	Below	
Dec		5.08	4.39		5.71	3.89	6.82	Avg	Avg	
TOTAL		27.30	26.67		37.07	32.85	40.58	Below	Below	

Deductions of Recent Weather Data: The precipitation in 2017 was above average for the site when the delineation was first conducted, there were saturated soils and shallow water tables at or above levels where hydric soils were observed. In Spring 2020 we made two visits, January 10 when conditions were wet, and April 15 when conditions were fairly dry. On the April 15 visit the precipitation was below average and the area was dry, no water in the stream and no water in the soil pits. On all other visits Kelso Road ditches were flooded and water was seen flowing through Wetland "A".

D) Methods: (site-specific methods for field investigation)

Wetland determinations and delineations discussed in this report were conducted in accordance with the 1987 U.S. Army Corps of Engineers Wetlands Delineation Manual ("the manual"), including regional supplements and applicable guidance, and supporting technical or guidance documents issued by the Department of State Lands.

In 2017 our investigations followed the mowing of the blackberries, and we were able to observe and traverse the site with ease. In 2020 the blackberries were again removed and the vegetation more or less the same as 2017 - recently mowed blackberries in the Wetland "A" area.

We dug soil test pits to a general depth of 16"-18" bgs. The soils in the area of Wetland "A" are often very reddish in color, particularly in the Northern end. However, we were able to discern hydric features in the soil.

We set wetland flags around the Wetland "A".

E) Description of All Wetlands and Other Non-Wetland Waters:

Wetland "A", 75,839 SQFT, 1.741 Acres. Wetland "A" starts at the Kelso Road Ditch and extends downslope and widens in a South West direction until crossing the West property boundary. As it is fed mainly by ditch flows, and is high up in its drainage, it probably dries out early in the summer.

The middle of the wetland has some shallow ponding created by the shallow ditch that runs through the center of the wetland becoming clogged with blackberry rubble and tire ruts from the mowing of the blackberries. In these puddles we observed bright green bubbly algae, the vigorous growth of which suggested fertilizer enrichment, probably fertilizer runoff from the nursery on the North side of SE Kelso Road.

West of the subject property, the wetland broadens out considerably, and flows onto lot 2300, where it is utilized as a horse pasture. About 1,000 feet to the south in Lot 2300, it connects with the stream that flows through lot 2203. The dominant vegetation in the upper portion is blackberries, and this transitions to pasture grasses in the lower section.

The Cowardin classification is Palustrine, Scrub Shrub, broad-leaved deciduous, Saturated, to Palustrine, Emergent, Persistent, Saturated, PSS1B to PEM1B. The HGM classification is sloped wetland.

F) Deviation from LWI or NWI:

The NWI map does not show any wetlands or waterways on lot 2204.

G) Mapping Method:

A property boundary survey and topographic survey was conducted by Toby Bolden, PLS 60377LS of Centerline Concepts. Centerline Concepts also located many of our wetland data plots and wetland boundary flags.

We used the TopCon GRS-1 GPS with a Topcon BR-1 beacon receiver for DGPS corrections for mapping some flags and plots either missed by the surveyors or added after their survey. These and other information shown in the figures were mapped as described in Section G.

H) Additional Information: (i.e., if needed to establish state jurisdiction)

None. All wetlands and waters described in this report are presumed to be jurisdictional.

I) Results and Conclusions:

Hydrology. The Hydrology on this site has been altered substantially from the historical conditions a long history of land use on this and neighboring properties, and by changes caused by roadways and

their associated ditches and culverts. Wetland "A" is thought to be created, or at least greatly enlarged by stormwater from higher in the drainage collected and concentrated into roadside ditches that discharge onto the Northern end of the property from the Kelso Road ditch.

Plants. Wetland "A" had Blackberries with some herbaceous plants, mostly grasses, in the wettest areas. There is also some mixed aged cottonwood and alder trees in the North part of the wetland.

Soils. Soils in the many areas are red in color, about 5YR3/3, which tended to mask hydric soil features in the margin of the wetland. There was a presence of what appeared to be manganese. Distinct differences were apparent between the soils south of the stream which tended to be 10YR 3/2 a darker less red soil and in the disturbed pasture grasses area.

Disclaimer: OAR141-090-0035(12)(j) :

"This report documents the investigation, best professional judgment and conclusions of the investigator. It is correct and complete to the best of my knowledge. It should be considered a Preliminary Jurisdictional Determination of wetlands and other waters and used at your own risk unless it has been reviewed and approved in writing by the Oregon Department of State Lands in accordance with OAR 141-090-0005 through 141-090-0055."

APPENDIX A - Maps:

- Figure 1: Location Map (Streamnet)
- Figure 2: Tax Map
- Figure 3: NWI Map
- Figure 4: Soil Map
- Figure 5: Aerial Photo (Google Earth 2017)
- Figure 6A: Wetland "A"
- Figure 6B: Wetland "A" enlarged

StreamNet



STUDY AREA INCLUDES ONLY THOSE PORTIONS OF LOT 2204 NOT PREVIOUSLY DELINEATED BY WD2018-0656

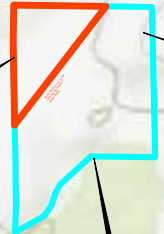

LOT 2204 CREATED BY PARTITIONING THE FORMER PROPERTY KNOWN AS 37090 SE KELSO ROAD

DIRECTIONS TO SITE:
 BY GPS, NAVIGATE TO 37090 SE KELSO ROAD, SANDY OR 97055.
 THE STREET ADDRESS AND HOUSE NO LONGER EXIST, BUT THIS WILL GET YOU CLOSE.

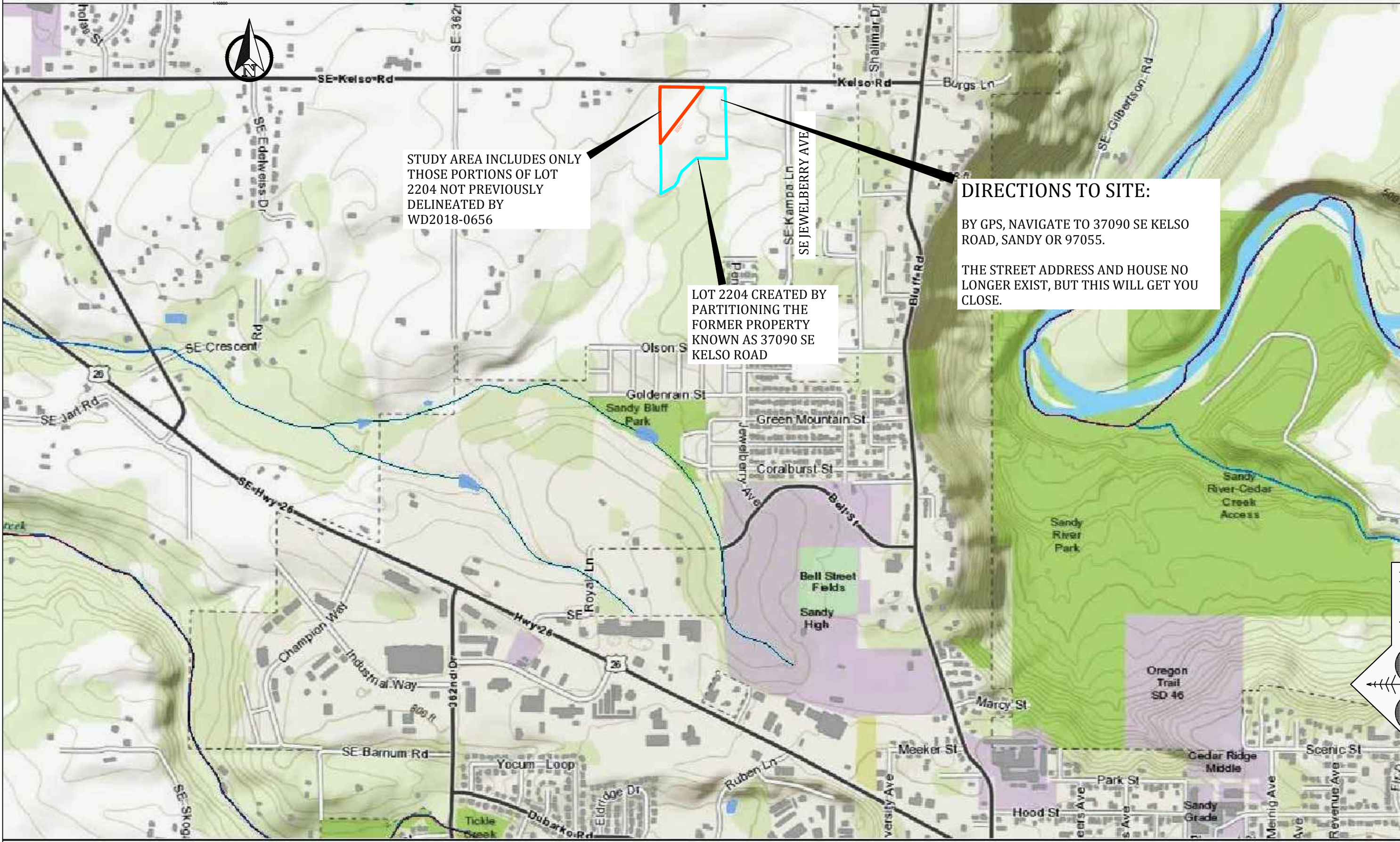

REVISIONS	

LOT 2204, SE KELSO RD
 Rosemont Development
 10117 SE Sunnyside Rd
 Clackamas, OR 97015

LOCATION MAP
 STREAMNET TOPO MAP USED FOR
 BACKGROUND

environmental
 technology
 consultants

PO Box 821185
 Vancouver, WA 98682
 360-696-4403

DATE	May 05, 2020
SCALE	NOTED
DRAWN	AM
JOB	EVA17010

FIGURE
1

1:18,056

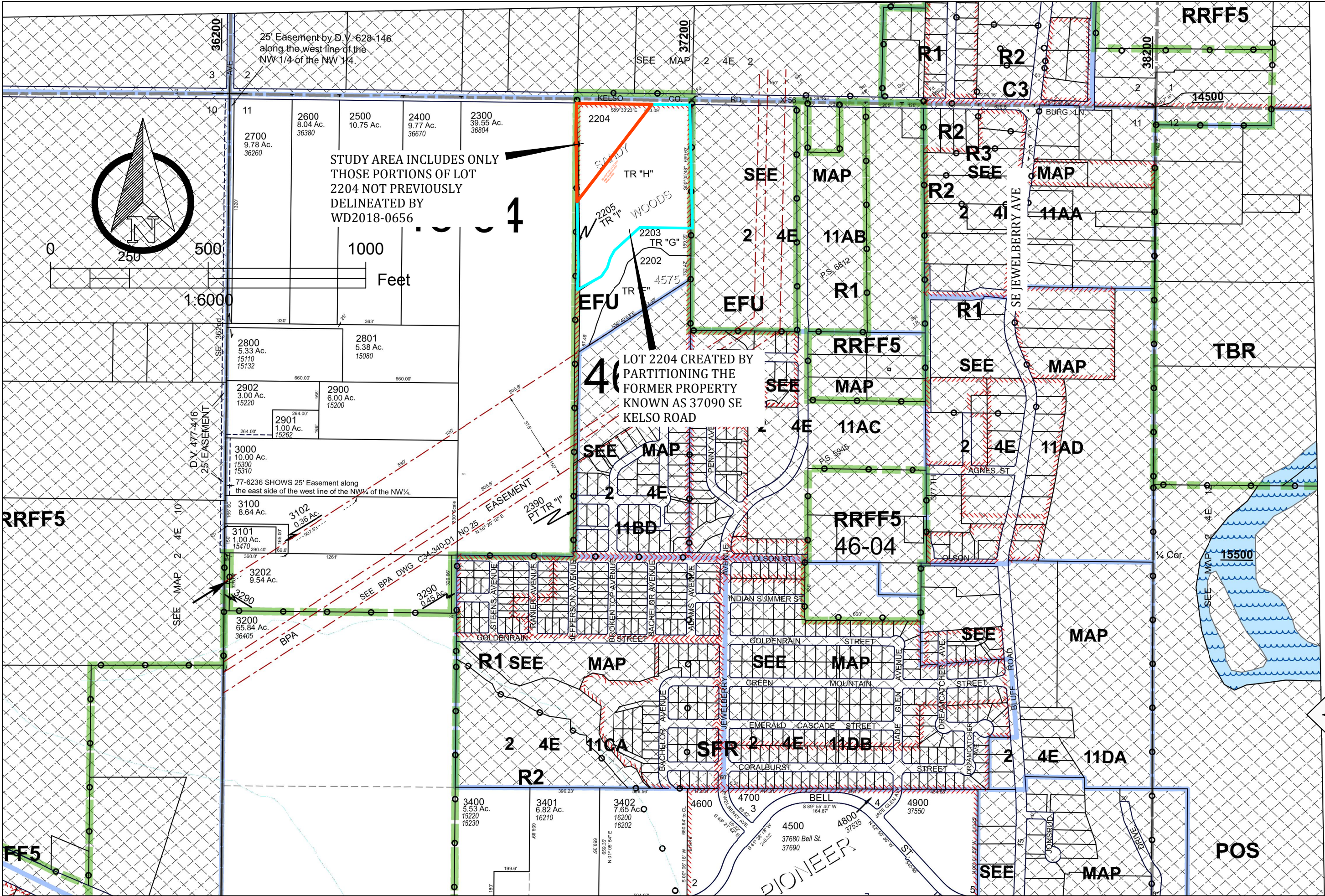

25' Easement by D.V. 628-146 along the west line of the NW 1/4 of the NW 1/4.

STUDY AREA INCLUDES ONLY THOSE PORTIONS OF LOT 2204 NOT PREVIOUSLY DELINEATED BY WD2018-0656

LOT 2204 CREATED BY PARTITIONING THE FORMER PROPERTY KNOWN AS 37090 SE KELSO ROAD

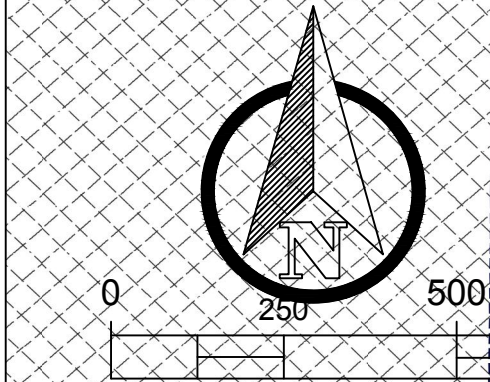

REVISIONS

LOT 2204, SE KELSO RD
 Rosemont Development
 10117 SE Sunnyside Rd
 Clackamas, OR 97015

TAX MAP
 REVISED 7/11/2019
 SECTION 11 T2s R4E,
 CLACKAMAS COUNTY

environmental
 technology
 consultants

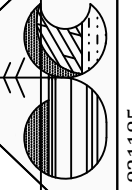

PO Box 821185
 Vancouver, WA 98682
 360-696-4403

DATE	May 05, 2020
SCALE	NOTED
DRAWN	AM
JOB	EVA17010
FIGURE	2



STUDY BOUNDARY
NWI map misses
large wetland area
in North part of lot.

NWI shows
unnamed stream
approximately
correctly on west
side of property.

LOT 2204.

NWI map show s
unnamed stream
flowing onto the
subject property
about 200' south of
it's actual position

37090 SE Kelso Rd

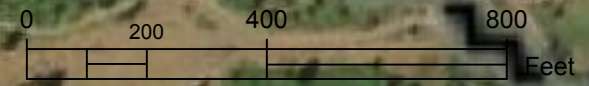

1995

REVISIONS	

LOT 2204, SE KELSO RD
Rosemont Development
10117 SE Sunnyside Rd
Clackamas, OR 97015

NWI MAP
USFWS NWI MAP LAYERS
IN GOOGLE EARTH

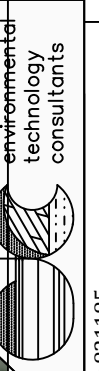

environmental
technology
consultants
PO Box 821185
Vancouver, WA 98682
360-696-4403

DATE	May 05, 2020
SCALE	NOTED
DRAWN	JHM
JOB	EVA17010

FIGURE
3

Imagery Date: 8/11/2016 45°24'51.38" N 122°16'

Clackamas County A	
Map Unit Symbol	Map Unit Name
15B	Cazadero silty clay loam, 0 to 7 percent slopes
15C	Cazadero silty clay loam, 7 to 12 percent slopes
24B	Cottrell silty clay loam, 2 to 8 percent slopes
31F	Dystrochrepts, very steep
84	Wapato silty clay loam

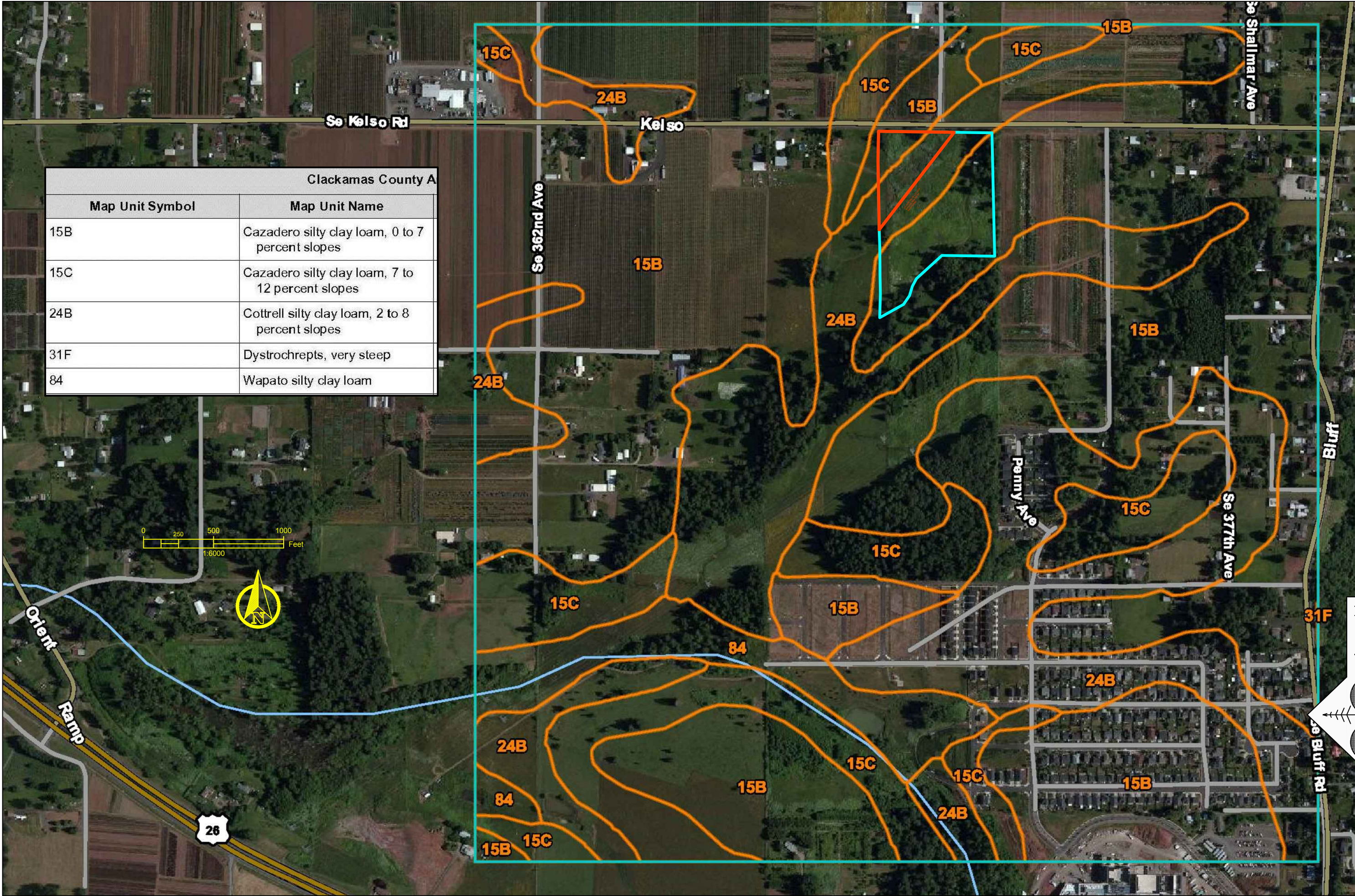
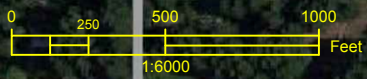

REVISIONS	

LOT 2204, SE KELSO RD
 Rosemont Development
 10117 SE Sunnyside Rd
 Clackamas, OR 97015

SOIL MAP
 NRCS NWI MAP LAYERS IN GOOGLE EARTH

environmental
 technology
 consultants

PO Box 821185
 Vancouver, WA 98682
 360-696-4403

DATE	May 05, 2020
SCALE	NOTED
DRAWN	JHM
JOB	EVA17010

FIGURE
4

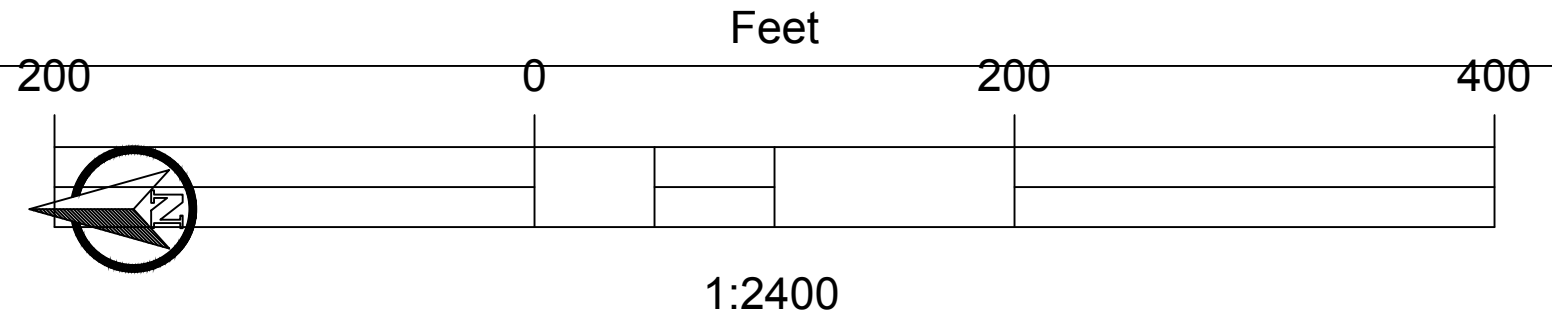

LOT 2204
STUDY BOUNDARY
INCLUDES ONLY THOSE
PORTIONS OF LOT 2204
NOT PREVIOUSLY
DELINEATED BY
WD2018-0656

REVISIONS	

LOT 2204, SE KELSO RD
Rosemont Development
10117 SE Sunnyside Rd
Clackamas, OR 97015

AERIAL PHOTO
GOOGLE EARTH 8/11/2017
USFWS NWI WETLAND LAYERS
DISPLAYED.

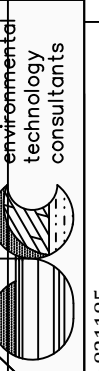

environmental
technology
consultants
PO Box 821185
Vancouver, WA 98682
360-696-4403

DATE	May 05, 2020
SCALE	NOTED
DRAWN	JHM
JOB	EVA17010

FIGURE
5

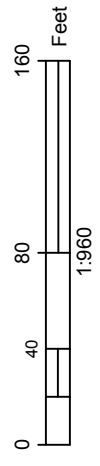

SE KELSO ROAD

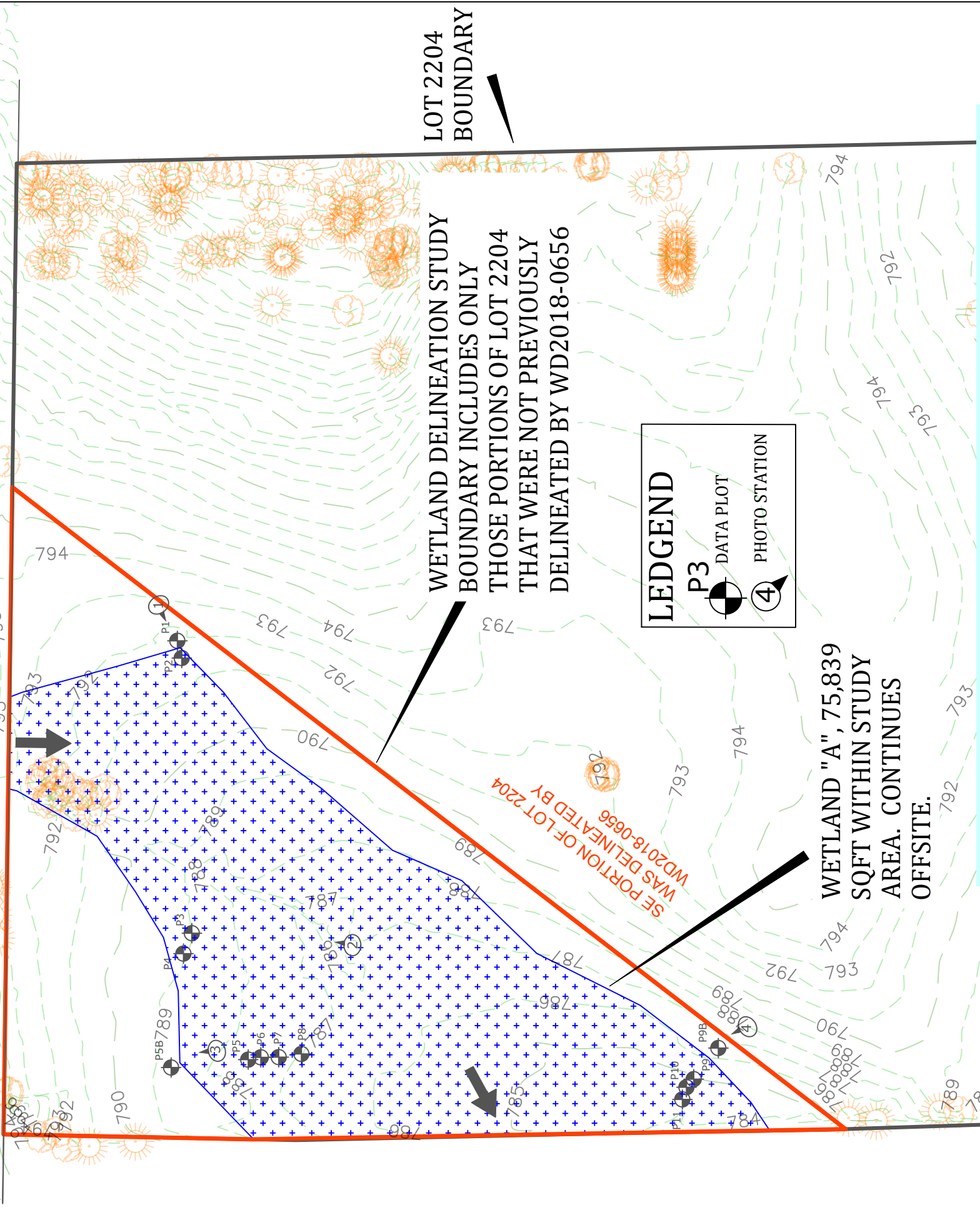

LOT 2204
BOUNDARY

WETLAND DELINEATION STUDY
BOUNDARY INCLUDES ONLY
THOSE PORTIONS OF LOT 2204
THAT WERE NOT PREVIOUSLY
DELINEATED BY WD2018-0656

LEDGEND

P3 DATA PLOT

4 PHOTO STATION

WETLAND "A", 75,839
SQFT WITHIN STUDY
AREA. CONTINUES
OFFSITE.

SE PORTION OF LOT 2204
WAS DELINEATED BY
WD2018-0656

**JASON,
HERE IS FIGURE 6A FROM WD2020-0442
SUBMITTED TO DSL AUGUST 24, 2020,
AND UNDER REVIEW AT THIS TIME.
BECAUSE WD2018-0656 DELINEATED THE
REMAINDER OF WHAT IS NOW LOT 2204,
DSL REQUIRED THAT THIS DELINEATION
INCLUDE ONLY THE NW CORNER OF THE
LOT WHICH HAD NOT BEEN PREVIOUSLY
DELINEATED. SORRY FOR ALL THE
COMMENT BUBBLES, THEY ARE SOME
ARTIFACT OF AUTOCAD'S PRINT DRIVER.**

141-0990-U055.

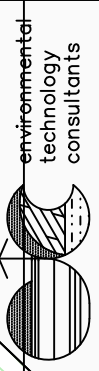

PO Box 821185
Vancouver, WA 98682
360-696-4403

WETLAND "A"
GOOGLE EARTH 8/11/2017
USFWS NW1 WETLAND LAYERS
DISPLAYED.

LOT 2204, SE KELSO RD
Rosemont Development
10117 SE Sunnyside Rd
Clackamas, OR 97015

DATE	May 05, 2020
SCALE	NOTED
DRAWN	JHM
JOB	EVA17010
FIGURE	6A
REVISIONS	

SE KELSO ROAD

WETLAND "A", 75,839 SQFT
WITHIN STUDY AREA.
CONTINUES OFFSITE TO THE
NORTH AND TO THE WEST

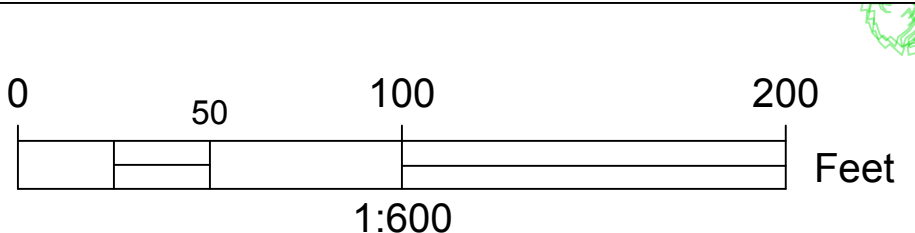

LEDGEND

P3 DATA PLOT

4 PHOTO STATION

Disclaimer per OAR 141-090-0035 (7)(k)

This report documents the investigation, best professional judgment and conclusions of the investigator. It is correct and complete to the best of my knowledge. It should be considered a Preliminary Jurisdictional Determination of wetlands and other waters and used at your own risk unless it has been reviewed and approved in writing by the Oregon Department of State Lands in accordance with OAR 141-090-0005 through 141-090-0055.

GPS MAPPING:
TOPCON GRS-1 RECEIVER USED WITH EXTERNAL ANTENNA, AND TOPCON BR1 BEACON RECEIVER USED FOR REAL TIME DGPS DATA CORRECTION.
ACCURACY = ±3FT HORIZONTAL
EXPORT USING
PROJECTION = SPC83-OREGON (NORTH) ,
DATUM = NAD83
GEOID = G2009U01
COORD TYPE = GRID

SE PORTION OF LOT 2204
WAS DELINEATED BY
WD2018-0656

WETLAND DELINEATION STUDY
BOUNDARY INCLUDES ONLY
THOSE PORTIONS OF LOT 2204
THAT WERE NOT PREVIOUSLY
DELINEATED BY WD2018-0656

DATE	May 05, 2020
SCALE	NOTED
DRAWN	JHM
JOB	EVA17010
FIGURE	6B

environmental
technology
consultants

PO Box 821185
Vancouver, WA 98682
360-696-4403

WETLAND "A"
GOOGLE EARTH 8/11/2017
USFWS NW1 WETLAND LAYERS
DISPLAYED.

LOT 2204, SE KELSO RD
Rosemont Development
10117 SE Sunnyside Rd
Clackamas, OR 97015

REVISIONS				

APPENDIX B - Data Forms

WETLAND DETERMINATION DATA FORM – Western Mountains, Valleys & Coast

Project/Site: 37090 Kelso RD City/County: Sandy/Clackamas Sampling Date: 3/30/2017
 Applicant/Owner: Joe Spaziani State: OR Sampling Point: P1
 Investigator(s): John McConnaughey, PWS# 2009 Section, Township, Range: T2S R4E S11
 Landform (hillslope, terrace, etc.): Valley Floor Local relief (concave, convex, none): Flat Slope (%): 1%
 Subregion (LRR): LRR-A Lat: 45.25078 Long: -122.16916 Datum: _____
 Soil Map Unit Name: Cazado silt loam, Cottrell silty clay loam NWI classification: _____

Are climatic / hydrologic conditions on the site typical for this time of year? Yes No (If no, explain in Remarks.)
 Are Vegetation YES, Soil _____, or Hydrology YES significantly disturbed? Are "Normal Circumstances" present? Yes No
 Are Vegetation YES, Soil _____, or Hydrology _____ naturally problematic? (If needed, explain any answers in Remarks.)

SUMMARY OF FINDINGS – Attach site map showing sampling point locations, transects, important features, etc.

Hydrophytic Vegetation Present? Yes <input checked="" type="checkbox"/> No <input type="checkbox"/> Hydric Soil Present? Yes <input type="checkbox"/> No <input checked="" type="checkbox"/> Wetland Hydrology Present? Yes <input checked="" type="checkbox"/> No <input type="checkbox"/>	Is the Sampled Area within a Wetland? Yes <input type="checkbox"/> No <input checked="" type="checkbox"/>
Remarks: Above average rainfall in March and April. This plot is in a mowed down blackberry field with hydrology coming in from drainage ditch along Kelso Road.	

VEGETATION – Use scientific names of plants.

	Absolute % Cover	Dominant Species?	Indicator Status	
Tree Stratum (Plot size: <u>30' East</u>)				
1. _____	_____	_____	_____	
2. <u>NO TREES</u>	_____	_____	_____	
3. _____	_____	_____	_____	
4. _____	_____	_____	_____	
	_____	= Total Cover		
Sapling/Shrub Stratum (Plot size: <u>30' East</u>)				
1. _____	_____	_____	_____	
2. _____	_____	_____	_____	
3. _____	_____	_____	_____	
4. _____	_____	_____	_____	
5. _____	_____	_____	_____	
	_____	= Total Cover		
Herb Stratum (Plot size: _____)				
1. <u>Rubus Armeniacus</u>	100	Y	FAC	
2. _____	_____	_____	_____	
3. _____	_____	_____	_____	
4. _____	_____	_____	_____	
5. _____	_____	_____	_____	
6. _____	_____	_____	_____	
7. _____	_____	_____	_____	
8. _____	_____	_____	_____	
	100	= Total Cover		
Woody Vine Stratum (Plot size: _____)				
1. _____	_____	_____	_____	
2. _____	_____	_____	_____	
	100	= Total Cover		
% Bare Ground in Herb Stratum <u>0</u> % Cover of Biotic Crust <u>0%</u>				
Remarks: minimal vegetation for identification because field was mowed.				

Dominance Test worksheet:
 Number of Dominant Species That Are OBL, FACW, or FAC: 1 (A)
 Total Number of Dominant Species Across All Strata: 1 (B)
 Percent of Dominant Species That Are OBL, FACW, or FAC: 100% (A/B)

Prevalence Index worksheet:
 Total % Cover of: _____ Multiply by: _____
 OBL species 0 x 1 = 0
 FACW species 0 x 2 = 0
 FAC species 0 x 3 = 0
 FACU species 0 x 4 = 0
 UPL species 0 x 5 = 0
 Column Totals: 0 (A) 0 (B)
 Prevalence Index = B/A = 0

Hydrophytic Vegetation Indicators:
 Dominance Test is >50%
 Prevalence Index is ≤3.0¹
 Morphological Adaptations¹ (Provide supporting data in Remarks or on a separate sheet)
 Problematic Hydrophytic Vegetation¹ (Explain)

¹Indicators of hydric soil and wetland hydrology must be present, unless disturbed or problematic.

Hydrophytic Vegetation Present? Yes No

SOIL

Sampling Point: P1 _____

Profile Description: (Describe to the depth needed to document the indicator or confirm the absence of indicators.)

Depth (inches)	Matrix		Redox Features				Texture	Remarks
	Color (moist)	%	Color (moist)	%	Type ¹	Loc ²		
0-5	7.5YR3/2	100					Silt loam	Lot's of roots
5-10	7.5YR4/4	90	7.5YR4/3	10	C	M	Silty clay loam	
10-18	7.5YR4/4	75	7.5YR4/3	25	C	M	Silty clay loam	

¹Type: C=Concentration, D=Depletion, RM=Reduced Matrix, CS=Covered or Coated Sand Grains. ²Location: PL=Pore Lining, M=Matrix.

Hydric Soil Indicators: (Applicable to all LRRs, unless otherwise noted.)

<input type="checkbox"/> Histosol (A1)	<input type="checkbox"/> Sandy Redox (S5)	<input type="checkbox"/> 1 cm Muck (A9) (LRR C)
<input type="checkbox"/> Histic Epipedon (A2)	<input type="checkbox"/> Stripped Matrix (S6)	<input type="checkbox"/> 2 cm Muck (A10) (LRR B)
<input type="checkbox"/> Black Histic (A3)	<input type="checkbox"/> Loamy Mucky Mineral (F1)	<input type="checkbox"/> Reduced Vertic (F18)
<input type="checkbox"/> Hydrogen Sulfide (A4)	<input type="checkbox"/> Loamy Gleyed Matrix (F2)	<input type="checkbox"/> Red Parent Material (TF2)
<input type="checkbox"/> Stratified Layers (A5) (LRR C)	<input type="checkbox"/> Depleted Matrix (F3)	<input type="checkbox"/> Other (Explain in Remarks)
<input type="checkbox"/> 1 cm Muck (A9) (LRR D)	<input type="checkbox"/> Redox Dark Surface (F6)	
<input type="checkbox"/> Depleted Below Dark Surface (A11)	<input type="checkbox"/> Depleted Dark Surface (F7)	
<input type="checkbox"/> Thick Dark Surface (A12)	<input type="checkbox"/> Redox Depressions (F8)	
<input type="checkbox"/> Sandy Mucky Mineral (S1)		
<input type="checkbox"/> Sandy Gleyed Matrix (S4)		

³Indicators of hydrophytic vegetation and wetland hydrology must be present, unless disturbed or problematic.

Restrictive Layer (if present):
 Type: Clay
 Depth (inches): 10

Hydric Soil Present? Yes No

Remarks:

HYDROLOGY

Wetland Hydrology Indicators:

<u>Primary Indicators (minimum of one required; check all that apply)</u>	<u>Secondary Indicators (2 or more required)</u>
<input type="checkbox"/> Surface Water (A1) <input checked="" type="checkbox"/> High Water Table (A2) <input checked="" type="checkbox"/> Saturation (A3) <input type="checkbox"/> Water Marks (B1) (Non riverine) <input type="checkbox"/> Sediment Deposits (B2) (Non riverine) <input type="checkbox"/> Drift Deposits (B3) (Non riverine) <input type="checkbox"/> Surface Soil Cracks (B6) <input type="checkbox"/> Inundation Visible on Aerial Imagery (B7) <input type="checkbox"/> Water-Stained Leaves (B9)	<input type="checkbox"/> Salt Crust (B11) <input type="checkbox"/> Biotic Crust (B12) <input type="checkbox"/> Aquatic Invertebrates (B13) <input type="checkbox"/> Hydrogen Sulfide Odor (C1) <input type="checkbox"/> Oxidized Rhizospheres along Living Roots (C3) <input type="checkbox"/> Presence of Reduced Iron (C4) <input type="checkbox"/> Recent Iron Reduction in Tilled Soils (C6) <input type="checkbox"/> Thin Muck Surface (C7) <input type="checkbox"/> Other (Explain in Remarks)
	<input type="checkbox"/> Water Marks (B1) (Riverine) <input type="checkbox"/> Sediment Deposits (B2) (Riverine) <input type="checkbox"/> Drift Deposits (B3) (Riverine) <input type="checkbox"/> Drainage Patterns (B10) <input type="checkbox"/> Dry-Season Water Table (C2) <input type="checkbox"/> Crayfish Burrows (C8) <input type="checkbox"/> Saturation Visible on Aerial Imagery (C9) <input type="checkbox"/> Shallow Aquitard (D3) <input type="checkbox"/> FAC-Neutral Test (D5)

Field Observations:

Surface Water Present? Yes No Depth (inches): _____

Water Table Present? Yes No Depth (inches): 10"

Saturation Present? (includes capillary fringe) Yes No Depth (inches): 10"

Wetland Hydrology Present? Yes No

Describe Recorded Data (stream gauge, monitoring well, aerial photos, previous inspections), if available: 4/17/17 no water, 5/1/17 12" bgs water table.

Remarks:

WETLAND DETERMINATION DATA FORM – Western Mountains, Valleys & Coast

Project/Site: 37090 Kelso RD City/County: Sandy/Clackamas Sampling Date: 3/30/2017
 Applicant/Owner: Joe Spaziani State: OR Sampling Point: P2
 Investigator(s): John McConnaughey, PWS# 2009 Section, Township, Range: T2S R4E S11
 Landform (hillslope, terrace, etc.): Valley Floor Local relief (concave, convex, none): Flat Slope (%): 6%
 Subregion (LRR): LRR-A Lat: 45.41800 Long: -122.28202 Datum: _____
 Soil Map Unit Name: Cazado silt loam, Cottrell silty clay loam NWI classification: No

Are climatic / hydrologic conditions on the site typical for this time of year? Yes No (If no, explain in Remarks.)
 Are Vegetation YES, Soil _____, or Hydrology YES significantly disturbed? Are "Normal Circumstances" present? Yes No
 Are Vegetation YES, Soil _____, or Hydrology _____ naturally problematic? (If needed, explain any answers in Remarks.)

SUMMARY OF FINDINGS – Attach site map showing sampling point locations, transects, important features, etc.

Hydrophytic Vegetation Present? Yes <input checked="" type="checkbox"/> No <input type="checkbox"/> Hydric Soil Present? Yes <input checked="" type="checkbox"/> No <input type="checkbox"/> Wetland Hydrology Present? Yes <input checked="" type="checkbox"/> No <input type="checkbox"/>	Is the Sampled Area within a Wetland? Yes <input checked="" type="checkbox"/> No <input type="checkbox"/>
Remarks: Above average rainfall in March and April. This plot is in a mowed down blackberry field, hydrology changed due to drainage ditch along Kelso Road.	

VEGETATION – Use scientific names of plants.

<u>Tree Stratum</u> (Plot size: <u>30'</u>)	<u>Absolute % Cover</u>	<u>Dominant Species?</u>	<u>Indicator Status</u>	
1. _____	_____	_____	_____	
2. <u>NO TREES</u>	_____	_____	_____	
3. _____	_____	_____	_____	
4. _____	_____	_____	_____	
	_____	= Total Cover		
<u>Sapling/Shrub Stratum</u> (Plot size: <u>30'</u>)				
1. _____	_____	_____	_____	
2. _____	_____	_____	_____	
3. _____	_____	_____	_____	
4. _____	_____	_____	_____	
5. _____	_____	_____	_____	
	_____	= Total Cover		
<u>Herb Stratum</u> (Plot size: <u>30'</u>)				
1. <u>Rubus Armeniacus</u>	<u>100</u>	<u>Y</u>	<u>FAC</u>	
2. _____	_____	_____	_____	
3. _____	_____	_____	_____	
4. _____	_____	_____	_____	
5. _____	_____	_____	_____	
6. _____	_____	_____	_____	
7. _____	_____	_____	_____	
8. _____	_____	_____	_____	
	<u>100</u>	= Total Cover		
<u>Woody Vine Stratum</u> (Plot size: _____)				
1. _____	_____	_____	_____	
2. _____	_____	_____	_____	
	<u>100</u>	= Total Cover		
% Bare Ground in Herb Stratum <u>0</u> % Cover of Biotic Crust <u>0%</u>				
Remarks: minimal vegetation for identification because field was mowed.				

Dominance Test worksheet:
 Number of Dominant Species That Are OBL, FACW, or FAC: 1 (A)
 Total Number of Dominant Species Across All Strata: 1 (B)
 Percent of Dominant Species That Are OBL, FACW, or FAC: 100% (A/B)

Prevalence Index worksheet:
 Total % Cover of: _____ Multiply by: _____
 OBL species 0 x 1 = 0
 FACW species 0 x 2 = 0
 FAC species 0 x 3 = 0
 FACU species 0 x 4 = 0
 UPL species 0 x 5 = 0
 Column Totals: 0 (A) 0 (B)
 Prevalence Index = B/A = 0

Hydrophytic Vegetation Indicators:
 Dominance Test is >50%
 Prevalence Index is ≤3.0¹
 Morphological Adaptations¹ (Provide supporting data in Remarks or on a separate sheet)
 Problematic Hydrophytic Vegetation¹ (Explain)

¹Indicators of hydric soil and wetland hydrology must be present, unless disturbed or problematic.

Hydrophytic Vegetation Present? Yes No

SOIL

Sampling Point: P2 _____

Profile Description: (Describe to the depth needed to document the indicator or confirm the absence of indicators.)

Depth (inches)	Matrix		Redox Features				Texture	Remarks
	Color (moist)	%	Color (moist)	%	Type ¹	Loc ²		
0-4	7.5YR3/2	100					Silt loam	
4-11	7.5YR3/2	95	5YR4/6	4	C	M	Silty clay loam	
			2.5n	1	C	M	Silty clay loam	
11-18	5YR2.5/1	95	5YR4/6	5	C	M	Clay	

¹Type: C=Concentration, D=Depletion, RM=Reduced Matrix, CS=Covered or Coated Sand Grains. ²Location: PL=Pore Lining, M=Matrix.

Hydric Soil Indicators: (Applicable to all LRRs, unless otherwise noted.)

<input type="checkbox"/> Histosol (A1)	<input type="checkbox"/> Sandy Redox (S5)	Indicators for Problematic Hydric Soils³:
<input type="checkbox"/> Histic Epipedon (A2)	<input type="checkbox"/> Stripped Matrix (S6)	
<input checked="" type="checkbox"/> Black Histic (A3)	<input type="checkbox"/> Loamy Mucky Mineral (F1)	
<input type="checkbox"/> Hydrogen Sulfide (A4)	<input type="checkbox"/> Loamy Gleyed Matrix (F2)	
<input type="checkbox"/> Stratified Layers (A5) (LRR C)	<input type="checkbox"/> Depleted Matrix (F3)	
<input type="checkbox"/> 1 cm Muck (A9) (LRR D)	<input checked="" type="checkbox"/> Redox Dark Surface (F6)	
<input type="checkbox"/> Depleted Below Dark Surface (A11)	<input type="checkbox"/> Depleted Dark Surface (F7)	
<input type="checkbox"/> Thick Dark Surface (A12)	<input type="checkbox"/> Redox Depressions (F8)	
<input type="checkbox"/> Sandy Mucky Mineral (S1)		
<input type="checkbox"/> Sandy Gleyed Matrix (S4)		

³Indicators of hydrophytic vegetation and wetland hydrology must be present, unless disturbed or problematic.

Restrictive Layer (if present):

Type: Clay

Depth (inches): 10

Hydric Soil Present? Yes No

Remarks:

HYDROLOGY

Wetland Hydrology Indicators:

Primary Indicators (minimum of one required; check all that apply)	Secondary Indicators (2 or more required)
<input type="checkbox"/> Surface Water (A1)	<input type="checkbox"/> Salt Crust (B11)
<input checked="" type="checkbox"/> High Water Table (A2)	<input type="checkbox"/> Biotic Crust (B12)
<input checked="" type="checkbox"/> Saturation (A3)	<input type="checkbox"/> Aquatic Invertebrates (B13)
<input type="checkbox"/> Water Marks (B1) (Non riverine)	<input type="checkbox"/> Hydrogen Sulfide Odor (C1)
<input type="checkbox"/> Sediment Deposits (B2) (Non riverine)	<input type="checkbox"/> Oxidized Rhizospheres along Living Roots (C3)
<input type="checkbox"/> Drift Deposits (B3) (Non riverine)	<input type="checkbox"/> Presence of Reduced Iron (C4)
<input type="checkbox"/> Surface Soil Cracks (B6)	<input type="checkbox"/> Recent Iron Reduction in Tilled Soils (C6)
<input type="checkbox"/> Inundation Visible on Aerial Imagery (B7)	<input type="checkbox"/> Thin Muck Surface (C7)
<input type="checkbox"/> Water-Stained Leaves (B9)	<input type="checkbox"/> Other (Explain in Remarks)
	<input type="checkbox"/> Water Marks (B1) (Riverine)
	<input type="checkbox"/> Sediment Deposits (B2) (Riverine)
	<input type="checkbox"/> Drift Deposits (B3) (Riverine)
	<input type="checkbox"/> Drainage Patterns (B10)
	<input type="checkbox"/> Dry-Season Water Table (C2)
	<input type="checkbox"/> Crayfish Burrows (C8)
	<input type="checkbox"/> Saturation Visible on Aerial Imagery (C9)
	<input type="checkbox"/> Shallow Aquitard (D3)
	<input type="checkbox"/> FAC-Neutral Test (D5)

Field Observations:

Surface Water Present? Yes No Depth (inches): _____

Water Table Present? Yes No Depth (inches): 7"

Saturation Present? Yes No Depth (inches): 7"
(includes capillary fringe)

Wetland Hydrology Present? Yes No

Describe Recorded Data (stream gauge, monitoring well, aerial photos, previous inspections), if available: 4/17/17 no water, 5/1/17 10" bgs water table.

Remarks:

WETLAND DETERMINATION DATA FORM – Western Mountains, Valleys & Coast

Project/Site: 37090 Kelso RD City/County: Sandy/Clackamas Sampling Date: 3/30/2017
 Applicant/Owner: Joe Spaziani State: OR Sampling Point: P3
 Investigator(s): John McConnaughey, PWS# 2009 Section, Township, Range: T2S R4E S11
 Landform (hillslope, terrace, etc.): Valley Floor Local relief (concave, convex, none): Flat Slope (%): 4%
 Subregion (LRR): LRR-A Lat: 45.25079 Long: -122.16961 Datum: _____
 Soil Map Unit Name: Cazado silt loam, Cottrell silty clay loam NWI classification: Not mapped

Are climatic / hydrologic conditions on the site typical for this time of year? Yes No (If no, explain in Remarks.)
 Are Vegetation YES, Soil _____, or Hydrology YES significantly disturbed? Are "Normal Circumstances" present? Yes No
 Are Vegetation YES, Soil _____, or Hydrology _____ naturally problematic? (If needed, explain any answers in Remarks.)

SUMMARY OF FINDINGS – Attach site map showing sampling point locations, transects, important features, etc.

Hydrophytic Vegetation Present? Yes <input checked="" type="checkbox"/> No <input type="checkbox"/> Hydric Soil Present? Yes <input checked="" type="checkbox"/> No <input type="checkbox"/> Wetland Hydrology Present? Yes <input checked="" type="checkbox"/> No <input type="checkbox"/>	Is the Sampled Area within a Wetland? Yes <input checked="" type="checkbox"/> No <input type="checkbox"/>
Remarks: Above average rainfall in March and April. This plot is in a mowed down blackberry field, hydrology altered by roadside ditch.	

VEGETATION – Use scientific names of plants.

	Absolute % Cover	Dominant Species?	Indicator Status	
Tree Stratum (Plot size: <u>30' East</u>)				
1. _____	_____	_____	_____	
2. <u>NO TREES</u>	_____	_____	_____	
3. _____	_____	_____	_____	
4. _____	_____	_____	_____	
	_____	= Total Cover		
Sapling/Shrub Stratum (Plot size: <u>30' East</u>)				
1. <u>Rubus Armeniacus</u> (recently mowed)	<u>100</u>	<u>Y</u>	<u>FAC</u>	
2. _____	_____	_____	_____	
3. _____	_____	_____	_____	
4. _____	_____	_____	_____	
5. _____	_____	_____	_____	
	<u>100</u>	= Total Cover		
Herb Stratum (Plot size: _____)				
1. _____	_____	_____	_____	
2. <u>Polystichum munitum</u>	<u>3</u>	<u>N</u>	<u>FACU</u>	
3. _____	_____	_____	_____	
4. _____	_____	_____	_____	
5. _____	_____	_____	_____	
6. _____	_____	_____	_____	
7. _____	_____	_____	_____	
8. _____	_____	_____	_____	
	<u>3</u>	= Total Cover		
Woody Vine Stratum (Plot size: _____)				
1. _____	_____	_____	_____	
2. _____	_____	_____	_____	
	_____	= Total Cover		
% Bare Ground in Herb Stratum <u>0</u> % Cover of Biotic Crust <u>0%</u>				
Remarks: minimal vegetation for identification because field was mowed.				

Dominance Test worksheet:
 Number of Dominant Species That Are OBL, FACW, or FAC: 1 (A)
 Total Number of Dominant Species Across All Strata: 1 (B)
 Percent of Dominant Species That Are OBL, FACW, or FAC: 100% (A/B)

Prevalence Index worksheet:
 Total % Cover of: _____ Multiply by: _____
 OBL species 0 x 1 = 0
 FACW species 0 x 2 = 0
 FAC species 0 x 3 = 0
 FACU species 0 x 4 = 0
 UPL species 0 x 5 = 0
 Column Totals: 0 (A) 0 (B)
 Prevalence Index = B/A = 0

Hydrophytic Vegetation Indicators:
 Dominance Test is >50%
 Prevalence Index is ≤3.0¹
 Morphological Adaptations¹ (Provide supporting data in Remarks or on a separate sheet)
 Problematic Hydrophytic Vegetation¹ (Explain)

¹Indicators of hydric soil and wetland hydrology must be present, unless disturbed or problematic.

Hydrophytic Vegetation Present? Yes No

SOIL

Sampling Point: P3 _____

Profile Description: (Describe to the depth needed to document the indicator or confirm the absence of indicators.)								
Depth (inches)	Matrix		Redox Features				Texture	Remarks
	Color (moist)	%	Color (moist)	%	Type ¹	Loc ²		
0-5	7.5YR3/2	100					Silt loam	
5-8	7.5YR3/2	97	5YR4/6	3	C	M	Silty clay loam	
			2.5n	1	C	M	Silty clay loam	
8-18	5YR2.3/3	90	5YR4/6	5	C	M	Clay	
			5YR2.5/1	5	C	M		

¹Type: C=Concentration, D=Depletion, RM=Reduced Matrix, CS=Covered or Coated Sand Grains. ²Location: PL=Pore Lining, M=Matrix.

Hydric Soil Indicators: (Applicable to all LRRs, unless otherwise noted.) <input type="checkbox"/> Histosol (A1) <input type="checkbox"/> Sandy Redox (S5) <input type="checkbox"/> Histic Epipedon (A2) <input type="checkbox"/> Stripped Matrix (S6) <input type="checkbox"/> Black Histic (A3) <input type="checkbox"/> Loamy Mucky Mineral (F1) <input type="checkbox"/> Hydrogen Sulfide (A4) <input type="checkbox"/> Loamy Gleyed Matrix (F2) <input type="checkbox"/> Stratified Layers (A5) (LRR C) <input type="checkbox"/> Depleted Matrix (F3) <input type="checkbox"/> 1 cm Muck (A9) (LRR D) <input checked="" type="checkbox"/> Redox Dark Surface (F6) <input type="checkbox"/> Depleted Below Dark Surface (A11) <input type="checkbox"/> Depleted Dark Surface (F7) <input type="checkbox"/> Thick Dark Surface (A12) <input type="checkbox"/> Redox Depressions (F8) <input type="checkbox"/> Sandy Mucky Mineral (S1) <input type="checkbox"/> Sandy Gleyed Matrix (S4)	Indicators for Problematic Hydric Soils³: <input type="checkbox"/> 1 cm Muck (A9) (LRR C) <input type="checkbox"/> 2 cm Muck (A10) (LRR B) <input type="checkbox"/> Reduced Vertic (F18) <input checked="" type="checkbox"/> Red Parent Material (TF2) <input type="checkbox"/> Other (Explain in Remarks)
--	---

³Indicators of hydrophytic vegetation and wetland hydrology must be present, unless disturbed or problematic.

Restrictive Layer (if present): Type: <u>Clay</u> Depth (inches): <u>10</u>	Hydric Soil Present? Yes <input checked="" type="checkbox"/> No <input type="checkbox"/>
--	---

Remarks: Soil is brittle

HYDROLOGY

Wetland Hydrology Indicators: <u>Primary Indicators (minimum of one required; check all that apply)</u> <input type="checkbox"/> Surface Water (A1) <input type="checkbox"/> Salt Crust (B11) <input checked="" type="checkbox"/> High Water Table (A2) <input type="checkbox"/> Biotic Crust (B12) <input checked="" type="checkbox"/> Saturation (A3) <input type="checkbox"/> Aquatic Invertebrates (B13) <input type="checkbox"/> Water Marks (B1) (Non riverine) <input type="checkbox"/> Hydrogen Sulfide Odor (C1) <input type="checkbox"/> Sediment Deposits (B2) (Non riverine) <input type="checkbox"/> Oxidized Rhizospheres along Living Roots (C3) <input type="checkbox"/> Drift Deposits (B3) (Non riverine) <input type="checkbox"/> Presence of Reduced Iron (C4) <input type="checkbox"/> Surface Soil Cracks (B6) <input type="checkbox"/> Recent Iron Reduction in Tilled Soils (C6) <input type="checkbox"/> Inundation Visible on Aerial Imagery (B7) <input type="checkbox"/> Thin Muck Surface (C7) <input type="checkbox"/> Water-Stained Leaves (B9) <input type="checkbox"/> Other (Explain in Remarks)		<u>Secondary Indicators (2 or more required)</u> <input type="checkbox"/> Water Marks (B1) (Riverine) <input type="checkbox"/> Sediment Deposits (B2) (Riverine) <input type="checkbox"/> Drift Deposits (B3) (Riverine) <input type="checkbox"/> Drainage Patterns (B10) <input type="checkbox"/> Dry-Season Water Table (C2) <input type="checkbox"/> Crayfish Burrows (C8) <input type="checkbox"/> Saturation Visible on Aerial Imagery (C9) <input type="checkbox"/> Shallow Aquitard (D3) <input type="checkbox"/> FAC-Neutral Test (D5)
---	--	---

Field Observations: Surface Water Present? Yes <input type="checkbox"/> No <input checked="" type="checkbox"/> Depth (inches): _____ Water Table Present? Yes <input checked="" type="checkbox"/> No <input type="checkbox"/> Depth (inches): <u>6"</u> Saturation Present? Yes <input checked="" type="checkbox"/> No <input type="checkbox"/> Depth (inches): <u>6"</u> (includes capillary fringe)	Wetland Hydrology Present? Yes <input checked="" type="checkbox"/> No <input type="checkbox"/>
---	---

Describe Recorded Data (stream gauge, monitoring well, aerial photos, previous inspections), if available: 4/17/17 no water, 5/1/17 9" bgs water table.

Remarks:

WETLAND DETERMINATION DATA FORM – Western Mountains, Valleys & Coast Region

Project/Site: 37090 Kelso RD City/County: Sandy/Clackamas Sampling Date: 3/30/2017
 Applicant/Owner: Joe Spaziani State: OR Sampling Point: P4
 Investigator(s): John McConnaughey, PWS# 2009 Section, Township, Range: T2S R4E S11
 Landform (hillslope, terrace, etc.): Valley Floor Local relief (concave, convex, none): Flat Slope (%): 3%
 Subregion (LRR): LRR-A Lat: 45.41796 Long: -122.20262 Datum: _____
 Soil Map Unit Name: Cazado silt loam, Cottrell silty clay loam NWI classification: Not mapped

Are climatic / hydrologic conditions on the site typical for this time of year? Yes No (If no, explain in Remarks.)
 Are Vegetation YES, Soil _____, or Hydrology YES significantly disturbed? Are "Normal Circumstances" present? Yes No
 Are Vegetation YES, Soil _____, or Hydrology _____ naturally problematic? (If needed, explain any answers in Remarks.)

SUMMARY OF FINDINGS – Attach site map showing sampling point locations, transects, important features, etc.

Hydrophytic Vegetation Present? Yes <input checked="" type="checkbox"/> No <input type="checkbox"/> Hydric Soil Present? Yes <input checked="" type="checkbox"/> No <input type="checkbox"/> Wetland Hydrology Present? Yes <input checked="" type="checkbox"/> No <input type="checkbox"/>	Is the Sampled Area within a Wetland? Yes <input checked="" type="checkbox"/> No <input type="checkbox"/>
Remarks: Above average rainfall in March and April. This plot is in a mowed down blackberry field, hydrology altered by roadside ditch draining water onto property. This was to be a boundary plot in the 2017 delineation, but we are now considering it just a wetland plot.	

VEGETATION – Use scientific names of plants.

	Absolute % Cover	Dominant Species?	Indicator Status		
Tree Stratum (Plot size: <u>30'</u>)					
1. _____	_____	_____	_____	Dominance Test worksheet: Number of Dominant Species That Are OBL, FACW, or FAC: <u>1</u> (A) Total Number of Dominant Species Across All Strata: <u>1</u> (B) Percent of Dominant Species That Are OBL, FACW, or FAC: <u>100%</u> (A/B)	
2. <u>NO TREES</u>	_____	_____	_____		
3. _____	_____	_____	_____		
4. _____	_____	_____	_____		
_____ = Total Cover				Prevalence Index worksheet: Total % Cover of: _____ Multiply by: _____ OBL species <u>0</u> x 1 = <u>0</u> FACW species <u>0</u> x 2 = <u>0</u> FAC species <u>0</u> x 3 = <u>0</u> FACU species <u>0</u> x 4 = <u>0</u> UPL species <u>0</u> x 5 = <u>0</u> Column Totals: <u>0</u> (A) <u>0</u> (B) Prevalence Index = B/A = <u>0</u>	
Sapling/Shrub Stratum (Plot size: <u>30'</u>)					
1. <u>Rubus Armeniacus (recently mowed)</u>	<u>100</u>	<u>Y</u>	<u>FAC</u>		
2. _____	_____	_____	_____		
3. _____	_____	_____	_____		
_____ = Total Cover					
Herb Stratum (Plot size: <u>30'</u>)					
1. _____	_____	_____	_____	Hydrophytic Vegetation Indicators: <input checked="" type="checkbox"/> Dominance Test is >50% <input type="checkbox"/> Prevalence Index is ≤3.0 ¹ <input type="checkbox"/> Morphological Adaptations ¹ (Provide supporting data in Remarks or on a separate sheet) <input type="checkbox"/> Problematic Hydrophytic Vegetation ¹ (Explain) ¹ Indicators of hydric soil and wetland hydrology must be present, unless disturbed or problematic.	
2. _____	_____	_____	_____		
3. _____	_____	_____	_____		
4. _____	_____	_____	_____		
5. _____	_____	_____	_____		
6. _____	_____	_____	_____		
7. _____	_____	_____	_____		
8. _____	_____	_____	_____		
_____ = Total Cover					
Woody Vine Stratum (Plot size: _____)					
1. _____	_____	_____	_____	Hydrophytic Vegetation Present? Yes <input checked="" type="checkbox"/> No <input type="checkbox"/>	
2. _____	_____	_____	_____		
_____ = Total Cover					
% Bare Ground in Herb Stratum <u>0</u>		% Cover of Biotic Crust <u>0%</u>			

Remarks: minimal vegetation for identification because field was mowed.

SOIL

Sampling Point: P4 _____

Profile Description: (Describe to the depth needed to document the indicator or confirm the absence of indicators.)								
Depth (inches)	Matrix		Redox Features				Texture	Remarks
	Color (moist)	%	Color (moist)	%	Type ¹	Loc ²		
0-5	7.5YR3/2	100					Silt loam	
5-11	7.5YR3/2	97	5YR4/6	3	C	M	Silty clay loam	
			2.5n	1	C	M	Silty clay loam	
11-18	5YR2.4/4	50	7.5YR3/2	50			Clay	Mixed matrix

¹Type: C=Concentration, D=Depletion, RM=Reduced Matrix, CS=Covered or Coated Sand Grains. ²Location: PL=Pore Lining, M=Matrix.

Hydric Soil Indicators: (Applicable to all LRRs, unless otherwise noted.) <input type="checkbox"/> Histosol (A1) <input type="checkbox"/> Histic Epipedon (A2) <input type="checkbox"/> Black Histic (A3) <input type="checkbox"/> Hydrogen Sulfide (A4) <input type="checkbox"/> Stratified Layers (A5) (LRR C) <input type="checkbox"/> 1 cm Muck (A9) (LRR D) <input type="checkbox"/> Depleted Below Dark Surface (A11) <input type="checkbox"/> Thick Dark Surface (A12) <input type="checkbox"/> Sandy Mucky Mineral (S1) <input type="checkbox"/> Sandy Gleyed Matrix (S4)	<input type="checkbox"/> Sandy Redox (S5) <input type="checkbox"/> Stripped Matrix (S6) <input type="checkbox"/> Loamy Mucky Mineral (F1) <input type="checkbox"/> Loamy Gleyed Matrix (F2) <input type="checkbox"/> Depleted Matrix (F3) <input checked="" type="checkbox"/> Redox Dark Surface (F6) <input type="checkbox"/> Depleted Dark Surface (F7) <input type="checkbox"/> Redox Depressions (F8)	Indicators for Problematic Hydric Soils³: <input type="checkbox"/> 1 cm Muck (A9) (LRR C) <input type="checkbox"/> 2 cm Muck (A10) (LRR B) <input type="checkbox"/> Reduced Vertic (F18) <input type="checkbox"/> Red Parent Material (TF2) <input type="checkbox"/> Other (Explain in Remarks)
--	--	--

³Indicators of hydrophytic vegetation and wetland hydrology must be present, unless disturbed or problematic.

Restrictive Layer (if present): Type: Clay _____ Depth (inches): 11 _____	Hydric Soil Present? Yes <input checked="" type="checkbox"/> No <input type="checkbox"/>
--	---

Remarks: The F6 indicator is not met with 3% redox features

HYDROLOGY

Wetland Hydrology Indicators: Primary Indicators (minimum of one required; check all that apply)			Secondary Indicators (2 or more required)		
<input type="checkbox"/> Surface Water (A1) <input checked="" type="checkbox"/> High Water Table (A2) <input checked="" type="checkbox"/> Saturation (A3) <input type="checkbox"/> Water Marks (B1) (Non riverine) <input type="checkbox"/> Sediment Deposits (B2) (Non riverine) <input type="checkbox"/> Drift Deposits (B3) (Non riverine) <input type="checkbox"/> Surface Soil Cracks (B6) <input type="checkbox"/> Inundation Visible on Aerial Imagery (B7) <input type="checkbox"/> Water-Stained Leaves (B9)	<input type="checkbox"/> Salt Crust (B11) <input type="checkbox"/> Biotic Crust (B12) <input type="checkbox"/> Aquatic Invertebrates (B13) <input type="checkbox"/> Hydrogen Sulfide Odor (C1) <input type="checkbox"/> Oxidized Rhizospheres along Living Roots (C3) <input type="checkbox"/> Presence of Reduced Iron (C4) <input type="checkbox"/> Recent Iron Reduction in Tilled Soils (C6) <input type="checkbox"/> Thin Muck Surface (C7) <input type="checkbox"/> Other (Explain in Remarks)	<input type="checkbox"/> Water Marks (B1) (Riverine) <input type="checkbox"/> Sediment Deposits (B2) (Riverine) <input type="checkbox"/> Drift Deposits (B3) (Riverine) <input type="checkbox"/> Drainage Patterns (B10) <input type="checkbox"/> Dry-Season Water Table (C2) <input type="checkbox"/> Crayfish Burrows (C8) <input type="checkbox"/> Saturation Visible on Aerial Imagery (C9) <input type="checkbox"/> Shallow Aquitard (D3) <input type="checkbox"/> FAC-Neutral Test (D5)			
Field Observations: Surface Water Present? Yes <input type="checkbox"/> No <input checked="" type="checkbox"/> Depth (inches): _____ Water Table Present? Yes <input checked="" type="checkbox"/> No <input type="checkbox"/> Depth (inches): 9" Saturation Present? Yes <input checked="" type="checkbox"/> No <input type="checkbox"/> Depth (inches): 9" (includes capillary fringe)			Wetland Hydrology Present? Yes <input checked="" type="checkbox"/> No <input type="checkbox"/>		
Describe Recorded Data (stream gauge, monitoring well, aerial photos, previous inspections), if available: 4/17/17 no water, 5/1/17 13" bgs water table.					
Remarks: The observed water table on 3/30/2017 may be above normal conditions. It lacked wetland hydrology on 2 other observations.					

WETLAND DETERMINATION DATA FORM – Western Mountains, Valleys & Coast Region

Project/Site: 37090 Kelso RD City/County: Sandy/Clackamas Sampling Date: 3/30/2017
 Applicant/Owner: Joe Spaziani State: OR Sampling Point: P5
 Investigator(s): John McConnaughey, PWS# 2009 Section, Township, Range: T2S R4E S11
 Landform (hillslope, terrace, etc.): Valley Floor Local relief (concave, convex, none): Flat Slope (%): 4%
 Subregion (LRR): LRR-A Lat: 45.25073 Long: -122.16980 Datum: _____
 Soil Map Unit Name: Cazado silt loam, Cottrell silty clay loam NWI classification: Not mapped

Are climatic / hydrologic conditions on the site typical for this time of year? Yes No (If no, explain in Remarks.)
 Are Vegetation YES, Soil _____, or Hydrology YES significantly disturbed? Are "Normal Circumstances" present? Yes No
 Are Vegetation YES, Soil _____, or Hydrology _____ naturally problematic? (If needed, explain any answers in Remarks.)

SUMMARY OF FINDINGS – Attach site map showing sampling point locations, transects, important features, etc.

Hydrophytic Vegetation Present? Yes <input checked="" type="checkbox"/> No <input type="checkbox"/> Hydric Soil Present? Yes <input type="checkbox"/> No <input checked="" type="checkbox"/> Wetland Hydrology Present? Yes <input type="checkbox"/> No <input checked="" type="checkbox"/>	Is the Sampled Area within a Wetland? Yes <input type="checkbox"/> No <input checked="" type="checkbox"/>
Remarks: Above average rainfall in March and April. This plot is in a mowed down blackberry field, hydrology altered by roadside ditch along Kelso Road that drains onto property.	

VEGETATION – Use scientific names of plants.

	Absolute % Cover	Dominant Species?	Indicator Status		
Tree Stratum (Plot size: <u>30'</u> north)					
1. _____	_____	_____	_____	Dominance Test worksheet: Number of Dominant Species That Are OBL, FACW, or FAC: <u>1</u> (A) Total Number of Dominant Species Across All Strata: <u>1</u> (B) Percent of Dominant Species That Are OBL, FACW, or FAC: <u>100%</u> (A/B)	
2. <u>NO TREES</u>	_____	_____	_____		
3. _____	_____	_____	_____		
4. _____	_____	_____	_____		
_____	_____	_____	_____		
_____ = Total Cover				Prevalence Index worksheet: Total % Cover of: _____ Multiply by: _____ OBL species <u>0</u> x 1 = <u>0</u> FACW species <u>0</u> x 2 = <u>0</u> FAC species <u>0</u> x 3 = <u>0</u> FACU species <u>0</u> x 4 = <u>0</u> UPL species <u>0</u> x 5 = <u>0</u> Column Totals: <u>0</u> (A) <u>0</u> (B) Prevalence Index = B/A = <u>0</u>	
Sapling/Shrub Stratum (Plot size: <u>30'</u> north)					
1. _____	_____	_____	_____		
2. _____	_____	_____	_____		
3. _____	_____	_____	_____		
4. _____	_____	_____	_____		
5. _____	_____	_____	_____		
_____ = Total Cover					
Herb Stratum (Plot size: <u>30'</u> north)					
1. <u>Rubus Armeniacus</u>	<u>95</u>	<u>Y</u>	<u>FAC</u>	Hydrophytic Vegetation Indicators: <input checked="" type="checkbox"/> Dominance Test is >50% <input type="checkbox"/> Prevalence Index is ≤3.0 ¹ <input type="checkbox"/> Morphological Adaptations ¹ (Provide supporting data in Remarks or on a separate sheet) <input type="checkbox"/> Problematic Hydrophytic Vegetation ¹ (Explain) ¹ Indicators of hydric soil and wetland hydrology must be present, unless disturbed or problematic.	
2. <u>Poa sp.</u>	<u>5</u>	<u>N</u>	<u>FAC</u>		
3. _____	_____	_____	_____		
4. _____	_____	_____	_____		
5. _____	_____	_____	_____		
6. _____	_____	_____	_____		
7. _____	_____	_____	_____		
8. _____	_____	_____	_____		
<u>103</u> = Total Cover					
Woody Vine Stratum (Plot size: _____)					
1. _____	_____	_____	_____		
2. _____	_____	_____	_____		
_____ = Total Cover					
% Bare Ground in Herb Stratum <u>0</u>		% Cover of Biotic Crust <u>0%</u>			
Remarks: minimal vegetation for identification because field was mowed.					

SOIL

Sampling Point: P5 _____

Profile Description: (Describe to the depth needed to document the indicator or confirm the absence of indicators.)								
Depth (inches)	Matrix		Redox Features				Texture	Remarks
	Color (moist)	%	Color (moist)	%	Type ¹	Loc ²		
0-4	7.5YR3/2	100					Silt loam	
4-10	7.5YR3/2	96	5YR4/6	3	C	M	Silty clay loam	
10-18	5YR2.3/3	60	10YR3/1	40			Clay	Mixed matrix

¹Type: C=Concentration, D=Depletion, RM=Reduced Matrix, CS=Covered or Coated Sand Grains. ²Location: PL=Pore Lining, M=Matrix.

Hydric Soil Indicators: (Applicable to all LRRs, unless otherwise noted.) <input type="checkbox"/> Histosol (A1) <input type="checkbox"/> Histic Epipedon (A2) <input type="checkbox"/> Black Histic (A3) <input type="checkbox"/> Hydrogen Sulfide (A4) <input type="checkbox"/> Stratified Layers (A5) (LRR C) <input type="checkbox"/> 1 cm Muck (A9) (LRR D) <input type="checkbox"/> Depleted Below Dark Surface (A11) <input type="checkbox"/> Thick Dark Surface (A12) <input type="checkbox"/> Sandy Mucky Mineral (S1) <input type="checkbox"/> Sandy Gleyed Matrix (S4)	Indicators for Problematic Hydric Soils³: <input type="checkbox"/> 1 cm Muck (A9) (LRR C) <input type="checkbox"/> 2 cm Muck (A10) (LRR B) <input type="checkbox"/> Reduced Vertic (F18) <input type="checkbox"/> Red Parent Material (TF2) <input type="checkbox"/> Other (Explain in Remarks)
--	--

³Indicators of hydrophytic vegetation and wetland hydrology must be present, unless disturbed or problematic.

Restrictive Layer (if present): Type: <u>Clay</u> Depth (inches): <u>10</u>	Hydric Soil Present? Yes <input checked="" type="checkbox"/> No <input type="checkbox"/>
--	---

Remarks: The F6 indicator is not met with 3% redox features

HYDROLOGY

Wetland Hydrology Indicators: Primary Indicators (minimum of one required; check all that apply)		Secondary Indicators (2 or more required)
<input type="checkbox"/> Surface Water (A1) <input checked="" type="checkbox"/> High Water Table (A2) <input checked="" type="checkbox"/> Saturation (A3) <input type="checkbox"/> Water Marks (B1) (Non riverine) <input type="checkbox"/> Sediment Deposits (B2) (Non riverine) <input type="checkbox"/> Drift Deposits (B3) (Non riverine) <input type="checkbox"/> Surface Soil Cracks (B6) <input type="checkbox"/> Inundation Visible on Aerial Imagery (B7) <input type="checkbox"/> Water-Stained Leaves (B9)	<input type="checkbox"/> Salt Crust (B11) <input type="checkbox"/> Biotic Crust (B12) <input type="checkbox"/> Aquatic Invertebrates (B13) <input type="checkbox"/> Hydrogen Sulfide Odor (C1) <input type="checkbox"/> Oxidized Rhizospheres along Living Roots (C3) <input type="checkbox"/> Presence of Reduced Iron (C4) <input type="checkbox"/> Recent Iron Reduction in Tilled Soils (C6) <input type="checkbox"/> Thin Muck Surface (C7) <input type="checkbox"/> Other (Explain in Remarks)	<input type="checkbox"/> Water Marks (B1) (Riverine) <input type="checkbox"/> Sediment Deposits (B2) (Riverine) <input type="checkbox"/> Drift Deposits (B3) (Riverine) <input type="checkbox"/> Drainage Patterns (B10) <input type="checkbox"/> Dry-Season Water Table (C2) <input type="checkbox"/> Crayfish Burrows (C8) <input type="checkbox"/> Saturation Visible on Aerial Imagery (C9) <input type="checkbox"/> Shallow Aquitard (D3) <input type="checkbox"/> FAC-Neutral Test (D5)
Field Observations: Surface Water Present? Yes <input type="checkbox"/> No <input checked="" type="checkbox"/> Depth (inches): _____ Water Table Present? Yes <input checked="" type="checkbox"/> No <input type="checkbox"/> Depth (inches): <u>9"</u> Saturation Present? Yes <input checked="" type="checkbox"/> No <input type="checkbox"/> Depth (inches): <u>9"</u> (includes capillary fringe)		Wetland Hydrology Present? Yes <input type="checkbox"/> No <input checked="" type="checkbox"/>
Describe Recorded Data (stream gauge, monitoring well, aerial photos, previous inspections), if available: 4/17/17 no water, 5/1/17 12" bgs water table.		
Remarks:		

WETLAND DETERMINATION DATA FORM – Western Mountains, Valleys & Coast Region

Project/Site: 37090 Kelso RD City/County: Sandy/Clackamas Sampling Date: 4/15/20
 Applicant/Owner: Joe Spaziani State: OR Sampling Point: P5B
 Investigator(s): John McConnaughey, PWS# 2009 Section, Township, Range: T2S R4E S11
 Landform (hillslope, terrace, etc.): Valley Floor Local relief (concave, convex, none): Flat Slope (%): 4%
 Subregion (LRR): LRR-A Lat: 45.25073 Long: -122.16980 Datum: _____
 Soil Map Unit Name: Cazado silt loam, Cottrell silty clay loam NWI classification: Not mapped

Are climatic / hydrologic conditions on the site typical for this time of year? Yes No (If no, explain in Remarks.)
 Are Vegetation YES, Soil _____, or Hydrology YES significantly disturbed? Are "Normal Circumstances" present? Yes No
 Are Vegetation YES, Soil _____, or Hydrology _____ naturally problematic? (If needed, explain any answers in Remarks.)

SUMMARY OF FINDINGS – Attach site map showing sampling point locations, transects, important features, etc.

Hydrophytic Vegetation Present? Yes <input checked="" type="checkbox"/> No <input type="checkbox"/> Hydric Soil Present? Yes <input checked="" type="checkbox"/> No <input type="checkbox"/> Wetland Hydrology Present? Yes <input type="checkbox"/> No <input checked="" type="checkbox"/>	Is the Sampled Area within a Wetland? Yes <input type="checkbox"/> No <input checked="" type="checkbox"/>
Remarks: Moved upland plot approximately 10' up the hillslope from plot 5. We have observed this area 4 times now since 2017 and concluded each time that wetland hydrology is absent.	

VEGETATION – Use scientific names of plants.

	Absolute % Cover	Dominant Species?	Indicator Status	
Tree Stratum (Plot size: <u>30'</u> north)				Dominance Test worksheet: Number of Dominant Species That Are OBL, FACW, or FAC: <u>4</u> (A) Total Number of Dominant Species Across All Strata: <u>4</u> (B) Percent of Dominant Species That Are OBL, FACW, or FAC: <u>100</u> (A/B)
1. _____	_____	_____	_____	
2. <u>NO TREES</u>	_____	_____	_____	
3. _____	_____	_____	_____	
4. _____	_____	_____	_____	
_____ = Total Cover				
Sapling/Shrub Stratum (Plot size: <u>30'</u> north)				Prevalence Index worksheet: Total % Cover of: _____ Multiply by: _____ OBL species <u>0</u> x 1 = <u>0</u> FACW species <u>0</u> x 2 = <u>0</u> FAC species <u>0</u> x 3 = <u>0</u> FACU species <u>0</u> x 4 = <u>0</u> UPL species <u>0</u> x 5 = <u>0</u> Column Totals: <u>0</u> (A) <u>0</u> (B) Prevalence Index = B/A = <u>0</u>
1. _____	_____	_____	_____	
2. _____	_____	_____	_____	
3. _____	_____	_____	_____	
4. _____	_____	_____	_____	
_____ = Total Cover				
Herb Stratum (Plot size: <u>30'</u> north)				Hydrophytic Vegetation Indicators: <input checked="" type="checkbox"/> Dominance Test is >50% <input type="checkbox"/> Prevalence Index is ≤3.0 ¹ <input type="checkbox"/> Morphological Adaptations ¹ (Provide supporting data in Remarks or on a separate sheet) <input type="checkbox"/> Problematic Hydrophytic Vegetation ¹ (Explain) ¹ Indicators of hydric soil and wetland hydrology must be present, unless disturbed or problematic.
1. <u>Rubus Armeniacus</u>	<u>25</u>	<u>Y</u>	<u>FAC</u>	
2. <u>Poa sp.</u>	<u>20</u>	<u>Y</u>	<u>FAC</u>	
3. <u>Cirsium arvense</u>	<u>25</u>	<u>Y</u>	<u>FAC</u>	
4. <u>Agrostis sp</u>	<u>20</u>	<u>Y</u>	<u>FAC</u>	
5. <u>Plantain lanceolata</u>	<u>15</u>	<u>N</u>	<u>FACU</u>	
6. _____	_____	_____	_____	
7. _____	_____	_____	_____	
8. _____	_____	_____	_____	
<u>105</u> = Total Cover				
Woody Vine Stratum (Plot size: _____)				
1. _____	_____	_____	_____	
2. _____	_____	_____	_____	
_____ = Total Cover				
% Bare Ground in Herb Stratum <u>0</u>				
Remarks: minimal vegetation for identification because field was mowed.				

SOIL

Sampling Point: P5B _____

Profile Description: (Describe to the depth needed to document the indicator or confirm the absence of indicators.)								
Depth (inches)	Matrix		Redox Features				Texture	Remarks
	Color (moist)	%	Color (moist)	%	Type ¹	Loc ²		
0-7	10YR3/3	97	7.5YR4/6	3	C	M	Silt loam	
7-16	10YR3/3	90	7.5YR4/6	10	C	M	Silty clay loam	

¹Type: C=Concentration, D=Depletion, RM=Reduced Matrix, CS=Covered or Coated Sand Grains. ²Location: PL=Pore Lining, M=Matrix.

Hydric Soil Indicators: (Applicable to all LRRs, unless otherwise noted.)

- | | |
|--|---|
| <input type="checkbox"/> Histosol (A1) | <input type="checkbox"/> Sandy Redox (S5) |
| <input type="checkbox"/> Histic Epipedon (A2) | <input type="checkbox"/> Stripped Matrix (S6) |
| <input type="checkbox"/> Black Histic (A3) | <input type="checkbox"/> Loamy Mucky Mineral (F1) |
| <input type="checkbox"/> Hydrogen Sulfide (A4) | <input type="checkbox"/> Loamy Gleyed Matrix (F2) |
| <input type="checkbox"/> Stratified Layers (A5) (LRR C) | <input type="checkbox"/> Depleted Matrix (F3) |
| <input type="checkbox"/> 1 cm Muck (A9) (LRR D) | <input checked="" type="checkbox"/> Redox Dark Surface (F6) |
| <input type="checkbox"/> Depleted Below Dark Surface (A11) | <input type="checkbox"/> Depleted Dark Surface (F7) |
| <input type="checkbox"/> Thick Dark Surface (A12) | <input type="checkbox"/> Redox Depressions (F8) |
| <input type="checkbox"/> Sandy Mucky Mineral (S1) | |
| <input type="checkbox"/> Sandy Gleyed Matrix (S4) | |

Indicators for Problematic Hydric Soils³:

- 1 cm Muck (A9) (LRR C)
- 2 cm Muck (A10) (LRR B)
- Reduced Vertic (F18)
- Red Parent Material (TF2)
- Other (Explain in Remarks)

³Indicators of hydrophytic vegetation and wetland hydrology must be present, unless disturbed or problematic.

Restrictive Layer (if present):

Type: _____

Depth (inches): _____

Hydric Soil Present? Yes No

Remarks: These soils may be relic, perhaps reflecting hydrological conditions that existed when the road and ditches upslope were in some other configuration.

HYDROLOGY

Wetland Hydrology Indicators:

Primary Indicators (minimum of one required; check all that apply)

- | | |
|--|--|
| <input type="checkbox"/> Surface Water (A1) | <input type="checkbox"/> Salt Crust (B11) |
| <input type="checkbox"/> High Water Table (A2) | <input type="checkbox"/> Biotic Crust (B12) |
| <input type="checkbox"/> Saturation (A3) | <input type="checkbox"/> Aquatic Invertebrates (B13) |
| <input type="checkbox"/> Water Marks (B1) (Non riverine) | <input type="checkbox"/> Hydrogen Sulfide Odor (C1) |
| <input type="checkbox"/> Sediment Deposits (B2) (Non riverine) | <input type="checkbox"/> Oxidized Rhizospheres along Living Roots (C3) |
| <input type="checkbox"/> Drift Deposits (B3) (Non riverine) | <input type="checkbox"/> Presence of Reduced Iron (C4) |
| <input type="checkbox"/> Surface Soil Cracks (B6) | <input type="checkbox"/> Recent Iron Reduction in Tilled Soils (C6) |
| <input type="checkbox"/> Inundation Visible on Aerial Imagery (B7) | <input type="checkbox"/> Thin Muck Surface (C7) |
| <input type="checkbox"/> Water-Stained Leaves (B9) | <input type="checkbox"/> Other (Explain in Remarks) |

Secondary Indicators (2 or more required)

- Water Marks (B1) (Riverine)
- Sediment Deposits (B2) (Riverine)
- Drift Deposits (B3) (Riverine)
- Drainage Patterns (B10)
- Dry-Season Water Table (C2)
- Crayfish Burrows (C8)
- Saturation Visible on Aerial Imagery (C9)
- Shallow Aquitard (D3)
- FAC-Neutral Test (D5)

Field Observations:

Surface Water Present? Yes No Depth (inches): _____

Water Table Present? Yes No Depth (inches): _____

Saturation Present? (includes capillary fringe) Yes No Depth (inches): _____

Wetland Hydrology Present? Yes No

Describe Recorded Data (stream gauge, monitoring well, aerial photos, previous inspections), if available: No indicators

Remarks: No water table or saturation observed to 16". This is the same what we observed in 2017 in this area, we conclude that this sloped area above the wetland lacks wetland hydrology.

WETLAND DETERMINATION DATA FORM – Arid West Region

Project/Site: 37090 Kelso RD City/County: Sandy/Clackamas Sampling Date: 3/30/2017
 Applicant/Owner: Joe Spaziani State: OR Sampling Point: P6
 Investigator(s): John McConnaughey, PWS# 2009 Section, Township, Range: T2S R4E S11
 Landform (hillslope, terrace, etc.): Valley Floor Local relief (concave, convex, none): Flat Slope (%): 4%
 Subregion (LRR): LRR-A Lat: 45.41796 Long: -122.20262 Datum: _____
 Soil Map Unit Name: Cazado silt loam, Cottrell silty clay loam NWI classification: Not mapped

Are climatic / hydrologic conditions on the site typical for this time of year? Yes No (If no, explain in Remarks.)
 Are Vegetation _____, Soil _____, or Hydrology YES significantly disturbed? Are "Normal Circumstances" present? Yes No
 Are Vegetation _____, Soil _____, or Hydrology _____ naturally problematic? (If needed, explain any answers in Remarks.)

SUMMARY OF FINDINGS – Attach site map showing sampling point locations, transects, important features, etc.

Hydrophytic Vegetation Present? Yes <input checked="" type="checkbox"/> No <input type="checkbox"/> Hydric Soil Present? Yes <input type="checkbox"/> No <input checked="" type="checkbox"/> Wetland Hydrology Present? Yes <input checked="" type="checkbox"/> No <input type="checkbox"/>	Is the Sampled Area within a Wetland? Yes <input checked="" type="checkbox"/> No <input type="checkbox"/>
Remarks: Above average rainfall in March and April. Vegetated patch not mowed, hydrology fed by roadside ditch	

VEGETATION – Use scientific names of plants.

	Absolute % Cover	Dominant Species?	Indicator Status		
Tree Stratum (Plot size: <u>3' cir</u>)					
1. _____	_____	_____	_____	Dominance Test worksheet: Number of Dominant Species That Are OBL, FACW, or FAC: <u>3</u> (A) Total Number of Dominant Species Across All Strata: <u>3</u> (B) Percent of Dominant Species That Are OBL, FACW, or FAC: <u>100%</u> (A/B)	
2. <u>NO TREES</u>	_____	_____	_____		
3. _____	_____	_____	_____		
4. _____	_____	_____	_____		
_____	_____	_____	_____		
_____ = Total Cover				Prevalence Index worksheet: Total % Cover of: _____ Multiply by: _____ OBL species <u>0</u> x 1 = <u>0</u> FACW species <u>0</u> x 2 = <u>0</u> FAC species <u>0</u> x 3 = <u>0</u> FACU species <u>0</u> x 4 = <u>0</u> UPL species <u>0</u> x 5 = <u>0</u> Column Totals: <u>0</u> (A) <u>0</u> (B) Prevalence Index = B/A = <u>0</u>	
Sapling/Shrub Stratum (Plot size: <u>3' cir</u>)					
1. <u>Rubus Armeniacus</u>	<u>30</u>	<u>Y</u>	<u>FAC</u>		
2. _____	_____	_____	_____		
3. _____	_____	_____	_____		
4. _____	_____	_____	_____		
5. _____	_____	_____	_____		
_____ = Total Cover				Hydrophytic Vegetation Indicators: <input checked="" type="checkbox"/> Dominance Test is >50% <input type="checkbox"/> Prevalence Index is ≤3.0 ¹ <input type="checkbox"/> Morphological Adaptations ¹ (Provide supporting data in Remarks or on a separate sheet) <input type="checkbox"/> Problematic Hydrophytic Vegetation ¹ (Explain) ¹ Indicators of hydric soil and wetland hydrology must be present, unless disturbed or problematic.	
Herb Stratum (Plot size: <u>3' cir</u>)					
1. <u>Agrostis sp</u>	<u>40</u>	<u>Y</u>	<u>FAC</u>		
2. <u>Poa sp.</u>	<u>40</u>	<u>Y</u>	<u>FAC</u>		
3. <u>Moss</u>	<u>80</u>	_____	_____		
4. <u>Galium aparine</u>	<u>2</u>	<u>N</u>	<u>FACU</u>		
5. <u>Herb 1</u>	<u>2</u>	<u>N</u>	<u>NA</u>		
6. <u>Herb 2</u>	<u>2</u>	<u>N</u>	<u>NA</u>		
7. _____	_____	_____	_____		
8. _____	_____	_____	_____		
_____ = Total Cover				Hydrophytic Vegetation Present? Yes <input checked="" type="checkbox"/> No <input type="checkbox"/>	
Woody Vine Stratum (Plot size: _____)					
1. _____	_____	_____	_____	Hydrophytic Vegetation Present? Yes <input checked="" type="checkbox"/> No <input type="checkbox"/>	
2. _____	_____	_____	_____		
_____ = Total Cover				Hydrophytic Vegetation Present? Yes <input checked="" type="checkbox"/> No <input type="checkbox"/>	
% Bare Ground in Herb Stratum <u>0</u> % Cover of Biotic Crust <u>0%</u>					
Remarks:					

SOIL

Sampling Point: P6 _____

Profile Description: (Describe to the depth needed to document the indicator or confirm the absence of indicators.)								
Depth (inches)	Matrix		Redox Features				Texture	Remarks
	Color (moist)	%	Color (moist)	%	Type ¹	Loc ²		
0-8	7.5YR3/2	100					Silt loam	
8-11	7.5YR3/2	95	5YR4/6	5	C	M	Silty clay loam	
11-18	7.5YR3/2	50					clay	
	5YR4/6	50						Mixed matrix

¹Type: C=Concentration, D=Depletion, RM=Reduced Matrix, CS=Covered or Coated Sand Grains. ²Location: PL=Pore Lining, M=Matrix.

<p>Hydric Soil Indicators: (Applicable to all LRRs, unless otherwise noted.)</p> <p><input type="checkbox"/> Histosol (A1)</p> <p><input type="checkbox"/> Histic Epipedon (A2)</p> <p><input type="checkbox"/> Black Histic (A3)</p> <p><input type="checkbox"/> Hydrogen Sulfide (A4)</p> <p><input type="checkbox"/> Stratified Layers (A5) (LRR C)</p> <p><input type="checkbox"/> 1 cm Muck (A9) (LRR D)</p> <p><input type="checkbox"/> Depleted Below Dark Surface (A11)</p> <p><input type="checkbox"/> Thick Dark Surface (A12)</p> <p><input type="checkbox"/> Sandy Mucky Mineral (S1)</p> <p><input type="checkbox"/> Sandy Gleyed Matrix (S4)</p>	<p>Indicators for Problematic Hydric Soils³:</p> <p><input type="checkbox"/> 1 cm Muck (A9) (LRR C)</p> <p><input type="checkbox"/> 2 cm Muck (A10) (LRR B)</p> <p><input type="checkbox"/> Reduced Vertic (F18)</p> <p><input type="checkbox"/> Red Parent Material (TF2)</p> <p><input type="checkbox"/> Other (Explain in Remarks)</p> <p>³Indicators of hydrophytic vegetation and wetland hydrology must be present, unless disturbed or problematic.</p>
---	---

<p>Restrictive Layer (if present):</p> <p>Type: <u>Clay</u></p> <p>Depth (inches): <u>11</u></p>	<p>Hydric Soil Present? Yes <input checked="" type="checkbox"/> No <input type="checkbox"/></p>
---	--

Remarks:

HYDROLOGY

<p>Wetland Hydrology Indicators:</p> <p><u>Primary Indicators (minimum of one required; check all that apply)</u></p> <p><input type="checkbox"/> Surface Water (A1)</p> <p><input checked="" type="checkbox"/> High Water Table (A2)</p> <p><input checked="" type="checkbox"/> Saturation (A3)</p> <p><input type="checkbox"/> Water Marks (B1) (Non riverine)</p> <p><input type="checkbox"/> Sediment Deposits (B2) (Non riverine)</p> <p><input type="checkbox"/> Drift Deposits (B3) (Non riverine)</p> <p><input type="checkbox"/> Surface Soil Cracks (B6)</p> <p><input type="checkbox"/> Inundation Visible on Aerial Imagery (B7)</p> <p><input type="checkbox"/> Water-Stained Leaves (B9)</p>		<p><u>Secondary Indicators (2 or more required)</u></p> <p><input type="checkbox"/> Salt Crust (B11)</p> <p><input type="checkbox"/> Biotic Crust (B12)</p> <p><input type="checkbox"/> Aquatic Invertebrates (B13)</p> <p><input type="checkbox"/> Hydrogen Sulfide Odor (C1)</p> <p><input type="checkbox"/> Oxidized Rhizospheres along Living Roots (C3)</p> <p><input type="checkbox"/> Presence of Reduced Iron (C4)</p> <p><input type="checkbox"/> Recent Iron Reduction in Tilled Soils (C6)</p> <p><input type="checkbox"/> Thin Muck Surface (C7)</p> <p><input type="checkbox"/> Other (Explain in Remarks)</p>
---	--	---

<p>Field Observations:</p> <p>Surface Water Present? Yes <input type="checkbox"/> No <input checked="" type="checkbox"/> Depth (inches): _____</p> <p>Water Table Present? Yes <input checked="" type="checkbox"/> No <input type="checkbox"/> Depth (inches): <u>7"</u></p> <p>Saturation Present? Yes <input checked="" type="checkbox"/> No <input type="checkbox"/> Depth (inches): <u>7"</u></p> <p>(includes capillary fringe)</p>	<p>Wetland Hydrology Present? Yes <input checked="" type="checkbox"/> No <input type="checkbox"/></p>
--	--

Describe Recorded Data (stream gauge, monitoring well, aerial photos, previous inspections), if available: 4/17/17 no water, 5/1/17 9" bgs water table.

Remarks:

WETLAND DETERMINATION DATA FORM – Arid West Region

Project/Site: 37090 Kelso RD City/County: Sandy/Clackamas Sampling Date: 3/30/2017
 Applicant/Owner: Joe Spaziani State: OR Sampling Point: P7
 Investigator(s): John McConnaughey, PWS# 2009 Section, Township, Range: T2S R4E S11
 Landform (hillslope, terrace, etc.): Valley Floor Local relief (concave, convex, none): Flat Slope (%): 2%
 Subregion (LRR): LRR-A Lat: 45.25066 Long: -122.16981 Datum: _____
 Soil Map Unit Name: Cazado silt loam, Cottrell silty clay loam NWI classification: Not mapped

Are climatic / hydrologic conditions on the site typical for this time of year? Yes No (If no, explain in Remarks.)
 Are Vegetation _____, Soil _____, or Hydrology YES significantly disturbed? Are "Normal Circumstances" present? Yes No
 Are Vegetation _____, Soil _____, or Hydrology _____ naturally problematic? (If needed, explain any answers in Remarks.)

SUMMARY OF FINDINGS – Attach site map showing sampling point locations, transects, important features, etc.

Hydrophytic Vegetation Present? Yes <input checked="" type="checkbox"/> No <input type="checkbox"/> Hydric Soil Present? Yes <input checked="" type="checkbox"/> No <input type="checkbox"/> Wetland Hydrology Present? Yes <input checked="" type="checkbox"/> No <input type="checkbox"/>	Is the Sampled Area within a Wetland? Yes <input checked="" type="checkbox"/> No <input type="checkbox"/>
Remarks: Above average rainfall in March and April. Vegetated patch not mowed, hydrology fed by roadside ditch along Kelso Road.	

VEGETATION – Use scientific names of plants.

	Absolute % Cover	Dominant Species?	Indicator Status	
Tree Stratum (Plot size: <u>30' East</u>)				
1. _____	_____	_____	_____	Dominance Test worksheet: Number of Dominant Species That Are OBL, FACW, or FAC: <u>1</u> (A) Total Number of Dominant Species Across All Strata: <u>3</u> (B) Percent of Dominant Species That Are OBL, FACW, or FAC: <u>33%</u> (A/B)
2. <u>NO TREES</u>	_____	_____	_____	
3. _____	_____	_____	_____	
4. _____	_____	_____	_____	
_____ = Total Cover	_____	_____	_____	
Sapling/Shrub Stratum (Plot size: <u>30' East</u>)				
1. _____	_____	_____	_____	Prevalence Index worksheet: Total % Cover of: _____ Multiply by: _____ OBL species <u>0</u> x 1 = <u>0</u> FACW species <u>0</u> x 2 = <u>0</u> FAC species <u>30</u> x 3 = <u>90</u> FACU species <u>80</u> x 4 = <u>320</u> UPL species <u>0</u> x 5 = <u>0</u> Column Totals: <u>110</u> (A) <u>410</u> (B) Prevalence Index = B/A = <u>3.7</u>
2. _____	_____	_____	_____	
3. _____	_____	_____	_____	
4. _____	_____	_____	_____	
5. _____	_____	_____	_____	
_____ = Total Cover	_____	_____	_____	
Herb Stratum (Plot size: _____)				
1. <u>Agrostis sp</u>	<u>25</u>	<u>Y</u>	<u>FAC</u>	Hydrophytic Vegetation Indicators: <input type="checkbox"/> Dominance Test is >50% <input type="checkbox"/> Prevalence Index is ≤3.0 ¹ <input type="checkbox"/> Morphological Adaptations ¹ (Provide supporting data in Remarks or on a separate sheet) <input type="checkbox"/> Problematic Hydrophytic Vegetation ¹ (Explain) ¹ Indicators of hydric soil and wetland hydrology must be present, unless disturbed or problematic.
2. <u>Anthoxanthum odoratum</u>	<u>55</u>	<u>Y</u>	<u>FACU</u>	
3. <u>Rubus armeniacus</u>	<u>5</u>	<u>N</u>	<u>FAC</u>	
4. <u>Taraxacum officinale</u>	<u>20</u>	<u>Y</u>	<u>FACU</u>	
5. <u>Hieracium albiflorum</u>	<u>5</u>	<u>N</u>	<u>NA</u>	
6. <u>Galium aparine</u>	<u>5</u>	<u>N</u>	<u>FACU</u>	
7. _____	_____	_____	_____	
8. _____	_____	_____	_____	
_____ = Total Cover	<u>103</u>	_____	_____	
Woody Vine Stratum (Plot size: _____)				
1. _____	_____	_____	_____	Hydrophytic Vegetation Present? Yes <input type="checkbox"/> No <input checked="" type="checkbox"/>
2. _____	_____	_____	_____	
_____ = Total Cover	_____	_____	_____	
% Bare Ground in Herb Stratum <u>0</u> % Cover of Biotic Crust <u>0%</u>				
Remarks: Prevalence test is 3.6 and 33% for Dominance test therefore not hydrophytic vegetation. Anthoxanthum odoratum is a problematic aggressive invasive.				

SOIL

Sampling Point: P7 _____

Profile Description: (Describe to the depth needed to document the indicator or confirm the absence of indicators.)								
Depth (inches)	Matrix		Redox Features				Texture	Remarks
	Color (moist)	%	Color (moist)	%	Type ¹	Loc ²		
0-9	7.5YR3/2	100					Silt loam	
9-11	7.5YR3/1	90	5YR4/6	10	C	M	Silty clay loam	
11-18	7.5YR2.5/2	95	5YR4/6	5	C	M	Silty clay loam	
¹ Type: C=Concentration, D=Depletion, RM=Reduced Matrix, CS=Covered or Coated Sand Grains. ² Location: PL=Pore Lining, M=Matrix.								
Hydric Soil Indicators: (Applicable to all LRRs, unless otherwise noted.)						Indicators for Problematic Hydric Soils³:		
<input type="checkbox"/> Histosol (A1) <input type="checkbox"/> Histic Epipedon (A2) <input type="checkbox"/> Black Histic (A3) <input type="checkbox"/> Hydrogen Sulfide (A4) <input type="checkbox"/> Stratified Layers (A5) (LRR C) <input type="checkbox"/> 1 cm Muck (A9) (LRR D) <input type="checkbox"/> Depleted Below Dark Surface (A11) <input type="checkbox"/> Thick Dark Surface (A12) <input type="checkbox"/> Sandy Mucky Mineral (S1) <input type="checkbox"/> Sandy Gleyed Matrix (S4)			<input type="checkbox"/> Sandy Redox (S5) <input type="checkbox"/> Stripped Matrix (S6) <input type="checkbox"/> Loamy Mucky Mineral (F1) <input type="checkbox"/> Loamy Gleyed Matrix (F2) <input type="checkbox"/> Depleted Matrix (F3) <input checked="" type="checkbox"/> Redox Dark Surface (F6) <input type="checkbox"/> Depleted Dark Surface (F7) <input type="checkbox"/> Redox Depressions (F8)			<input type="checkbox"/> 1 cm Muck (A9) (LRR C) <input type="checkbox"/> 2 cm Muck (A10) (LRR B) <input type="checkbox"/> Reduced Vertic (F18) <input checked="" type="checkbox"/> Red Parent Material (TF2) <input type="checkbox"/> Other (Explain in Remarks)		
Restrictive Layer (if present): Type: <u>Clay</u> Depth (inches): <u>11</u>						³ Indicators of hydrophytic vegetation and wetland hydrology must be present, unless disturbed or problematic.		
Hydric Soil Present? Yes <input checked="" type="checkbox"/> No <input type="checkbox"/>								
Remarks: Extremely wet. Hard to see indicators								

HYDROLOGY

Wetland Hydrology Indicators:			
Primary Indicators (minimum of one required; check all that apply)		Secondary Indicators (2 or more required)	
<input type="checkbox"/> Surface Water (A1)	<input type="checkbox"/> Salt Crust (B11)	<input type="checkbox"/> Water Marks (B1) (Riverine)	
<input checked="" type="checkbox"/> High Water Table (A2)	<input type="checkbox"/> Biotic Crust (B12)	<input type="checkbox"/> Sediment Deposits (B2) (Riverine)	
<input checked="" type="checkbox"/> Saturation (A3)	<input type="checkbox"/> Aquatic Invertebrates (B13)	<input type="checkbox"/> Drift Deposits (B3) (Riverine)	
<input type="checkbox"/> Water Marks (B1) (Non riverine)	<input type="checkbox"/> Hydrogen Sulfide Odor (C1)	<input type="checkbox"/> Drainage Patterns (B10)	
<input type="checkbox"/> Sediment Deposits (B2) (Non riverine)	<input type="checkbox"/> Oxidized Rhizospheres along Living Roots (C3)	<input type="checkbox"/> Dry-Season Water Table (C2)	
<input type="checkbox"/> Drift Deposits (B3) (Non riverine)	<input type="checkbox"/> Presence of Reduced Iron (C4)	<input type="checkbox"/> Crayfish Burrows (C8)	
<input type="checkbox"/> Surface Soil Cracks (B6)	<input type="checkbox"/> Recent Iron Reduction in Tilled Soils (C6)	<input type="checkbox"/> Saturation Visible on Aerial Imagery (C9)	
<input type="checkbox"/> Inundation Visible on Aerial Imagery (B7)	<input type="checkbox"/> Thin Muck Surface (C7)	<input type="checkbox"/> Shallow Aquitard (D3)	
<input type="checkbox"/> Water-Stained Leaves (B9)	<input type="checkbox"/> Other (Explain in Remarks)	<input type="checkbox"/> FAC-Neutral Test (D5)	
Field Observations:		Wetland Hydrology Present? Yes <input checked="" type="checkbox"/> No <input type="checkbox"/>	
Surface Water Present?	Yes <input type="checkbox"/> No <input checked="" type="checkbox"/> Depth (inches): _____		
Water Table Present?	Yes <input checked="" type="checkbox"/> No <input type="checkbox"/> Depth (inches): <u>5"</u>		
Saturation Present? (includes capillary fringe)	Yes <input checked="" type="checkbox"/> No <input type="checkbox"/> Depth (inches): <u>5"</u>		
Describe Recorded Data (stream gauge, monitoring well, aerial photos, previous inspections), if available: 4/17/17 no water, 5/1/17 8" bgs water table.			
Remarks:			

WETLAND DETERMINATION DATA FORM – Arid West Region

Project/Site: 37090 Kelso RD City/County: Sandy/Clackamas Sampling Date: 3/30/2017
 Applicant/Owner: Joe Spaziani State: OR Sampling Point: P8
 Investigator(s): John McConnaughey, PWS# 2009 Section, Township, Range: T2S R4E S11
 Landform (hillslope, terrace, etc.): Valley Floor Local relief (concave, convex, none): Flat Slope (%): 3%
 Subregion (LRR): LRR-A Lat: 45.25067 Long: -122.16979 Datum: _____
 Soil Map Unit Name: Cazado silt loam, Cottrell silty clay loam NWI classification: Not mapped

Are climatic / hydrologic conditions on the site typical for this time of year? Yes No (If no, explain in Remarks.)
 Are Vegetation YES, Soil _____, or Hydrology _____ significantly disturbed? Are "Normal Circumstances" present? Yes No
 Are Vegetation YES, Soil _____, or Hydrology _____ naturally problematic? (If needed, explain any answers in Remarks.)

SUMMARY OF FINDINGS – Attach site map showing sampling point locations, transects, important features, etc.

Hydrophytic Vegetation Present? Yes <input type="checkbox"/> No <input checked="" type="checkbox"/> Hydric Soil Present? Yes <input checked="" type="checkbox"/> No <input type="checkbox"/> Wetland Hydrology Present? Yes <input checked="" type="checkbox"/> No <input type="checkbox"/>	Is the Sampled Area within a Wetland? Yes <input checked="" type="checkbox"/> No <input type="checkbox"/>
Remarks: Above average rainfall in March and April. Vegetated patch not mowed, hydrology altered by roadside ditch along Kelso Road	

VEGETATION – Use scientific names of plants.

	Absolute % Cover	Dominant Species?	Indicator Status	
Tree Stratum (Plot size: <u>5'cir</u>)				
1. _____	_____	_____	_____	Dominance Test worksheet: Number of Dominant Species That Are OBL, FACW, or FAC: <u>1</u> (A) Total Number of Dominant Species Across All Strata: <u>2</u> (B) Percent of Dominant Species That Are OBL, FACW, or FAC: <u>50%</u> (A/B)
2. <u>NO TREES</u>	_____	_____	_____	
3. _____	_____	_____	_____	
4. _____	_____	_____	_____	
_____ = Total Cover	_____	_____	_____	
Sapling/Shrub Stratum (Plot size: <u>5'cir</u>)				
1. _____	_____	_____	_____	Prevalence Index worksheet: Total % Cover of: _____ Multiply by: _____ OBL species <u>0</u> x 1 = <u>0</u> FACW species <u>0</u> x 2 = <u>0</u> FAC species <u>45</u> x 3 = <u>135</u> FACU species <u>83</u> x 4 = <u>332</u> UPL species <u>0</u> x 5 = <u>0</u> Column Totals: <u>128</u> (A) <u>467</u> (B) Prevalence Index = B/A = <u>3.6</u>
2. _____	_____	_____	_____	
3. _____	_____	_____	_____	
4. _____	_____	_____	_____	
5. _____	_____	_____	_____	
_____ = Total Cover	_____	_____	_____	
Herb Stratum (Plot size: <u>5' cir</u>)				
1. <u>Agrostis sp</u>	<u>40</u>	<u>Y</u>	<u>FAC</u>	Hydrophytic Vegetation Indicators: <input type="checkbox"/> Dominance Test is >50% <input checked="" type="checkbox"/> Prevalence Index is ≤3.0 ¹ <input type="checkbox"/> Morphological Adaptations ¹ (Provide supporting data in Remarks or on a separate sheet) <input checked="" type="checkbox"/> Problematic Hydrophytic Vegetation ¹ (Explain) ¹ Indicators of hydric soil and wetland hydrology must be present, unless disturbed or problematic.
2. <u>Anthoxanthum odoratum</u>	<u>58</u>	<u>Y</u>	<u>FACU</u>	
3. <u>Holcus lanatus</u>	<u>5</u>	<u>N</u>	<u>FAC</u>	
4. <u>Taraxacum officinale</u>	<u>10</u>	<u>N</u>	<u>FACU</u>	
5. <u>Hypochaeris radicata</u>	<u>15</u>	<u>N</u>	<u>FACU</u>	
6. _____	_____	_____	_____	
7. _____	_____	_____	_____	
8. _____	_____	_____	_____	
_____ = Total Cover	<u>128</u>	_____	_____	
Woody Vine Stratum (Plot size: _____)				
1. _____	_____	_____	_____	Hydrophytic Vegetation Present? Yes <input type="checkbox"/> No <input checked="" type="checkbox"/>
2. _____	_____	_____	_____	
_____ = Total Cover	_____	_____	_____	
% Bare Ground in Herb Stratum <u>0</u> % Cover of Biotic Crust <u>0%</u>				
Remarks: Prevalence Index test is 3.6 and Dominance is 50% (not greater) so not hydrophytic vegetation. Anthoxanthum is an problematic aggressive invasive.				

SOIL

Sampling Point: P8 _____

Profile Description: (Describe to the depth needed to document the indicator or confirm the absence of indicators.)								
Depth (inches)	Matrix		Redox Features				Texture	Remarks
	Color (moist)	%	Color (moist)	%	Type ¹	Loc ²		
0-8	7.5YR5/3	100					Silt loam	
8-12	7.5YR2.5/1	100					Silty clay loam	
12-18	5YR3/4	100					Silty clay loam	
¹ Type: C=Concentration, D=Depletion, RM=Reduced Matrix, CS=Covered or Coated Sand Grains. ² Location: PL=Pore Lining, M=Matrix.								
Hydric Soil Indicators: (Applicable to all LRRs, unless otherwise noted.)				Indicators for Problematic Hydric Soils³:				
<input type="checkbox"/> Histosol (A1)			<input type="checkbox"/> Sandy Redox (S5)			<input type="checkbox"/> 1 cm Muck (A9) (LRR C)		
<input type="checkbox"/> Histic Epipedon (A2)			<input type="checkbox"/> Stripped Matrix (S6)			<input type="checkbox"/> 2 cm Muck (A10) (LRR B)		
<input type="checkbox"/> Black Histic (A3)			<input type="checkbox"/> Loamy Mucky Mineral (F1)			<input type="checkbox"/> Reduced Vertic (F18)		
<input type="checkbox"/> Hydrogen Sulfide (A4)			<input type="checkbox"/> Loamy Gleyed Matrix (F2)			<input checked="" type="checkbox"/> Red Parent Material (TF2)		
<input type="checkbox"/> Stratified Layers (A5) (LRR C)			<input checked="" type="checkbox"/> Depleted Matrix (F3)			<input type="checkbox"/> Other (Explain in Remarks)		
<input type="checkbox"/> 1 cm Muck (A9) (LRR D)			<input type="checkbox"/> Redox Dark Surface (F6)			³ Indicators of hydrophytic vegetation and wetland hydrology must be present, unless disturbed or problematic.		
<input type="checkbox"/> Depleted Below Dark Surface (A11)			<input type="checkbox"/> Depleted Dark Surface (F7)					
<input type="checkbox"/> Thick Dark Surface (A12)			<input type="checkbox"/> Redox Depressions (F8)					
<input type="checkbox"/> Sandy Mucky Mineral (S1)								
<input type="checkbox"/> Sandy Gleyed Matrix (S4)								
Restrictive Layer (if present):						Hydric Soil Present? Yes <input checked="" type="checkbox"/> No <input type="checkbox"/>		
Type: <u>Clay</u>								
Depth (inches): <u>12</u>								
Remarks: Extremely wet. Hard to see indicators								

HYDROLOGY

Wetland Hydrology Indicators:			
Primary Indicators (minimum of one required; check all that apply)		Secondary Indicators (2 or more required)	
<input type="checkbox"/> Surface Water (A1)		<input type="checkbox"/> Salt Crust (B11)	<input type="checkbox"/> Water Marks (B1) (Riverine)
<input checked="" type="checkbox"/> High Water Table (A2)		<input type="checkbox"/> Biotic Crust (B12)	<input type="checkbox"/> Sediment Deposits (B2) (Riverine)
<input checked="" type="checkbox"/> Saturation (A3)		<input type="checkbox"/> Aquatic Invertebrates (B13)	<input type="checkbox"/> Drift Deposits (B3) (Riverine)
<input type="checkbox"/> Water Marks (B1) (Non riverine)		<input type="checkbox"/> Hydrogen Sulfide Odor (C1)	<input type="checkbox"/> Drainage Patterns (B10)
<input type="checkbox"/> Sediment Deposits (B2) (Non riverine)		<input type="checkbox"/> Oxidized Rhizospheres along Living Roots (C3)	<input type="checkbox"/> Dry-Season Water Table (C2)
<input type="checkbox"/> Drift Deposits (B3) (Non riverine)		<input type="checkbox"/> Presence of Reduced Iron (C4)	<input type="checkbox"/> Crayfish Burrows (C8)
<input type="checkbox"/> Surface Soil Cracks (B6)		<input type="checkbox"/> Recent Iron Reduction in Tilled Soils (C6)	<input type="checkbox"/> Saturation Visible on Aerial Imagery (C9)
<input type="checkbox"/> Inundation Visible on Aerial Imagery (B7)		<input type="checkbox"/> Thin Muck Surface (C7)	<input type="checkbox"/> Shallow Aquitard (D3)
<input type="checkbox"/> Water-Stained Leaves (B9)		<input type="checkbox"/> Other (Explain in Remarks)	<input type="checkbox"/> FAC-Neutral Test (D5)
Field Observations:		Wetland Hydrology Present? Yes <input checked="" type="checkbox"/> No <input type="checkbox"/>	
Surface Water Present?	Yes <input checked="" type="checkbox"/> No <input type="checkbox"/>	Depth (inches): <u>1/4"</u>	
Water Table Present?	Yes <input checked="" type="checkbox"/> No <input type="checkbox"/>	Depth (inches): _____	
Saturation Present? (includes capillary fringe)	Yes <input checked="" type="checkbox"/> No <input type="checkbox"/>	Depth (inches): _____	
Describe Recorded Data (stream gauge, monitoring well, aerial photos, previous inspections), if available: 4/17/17 no water, 5/1/17 1/4"standing water			
Remarks:			

WETLAND DETERMINATION DATA FORM – Arid West Region

Project/Site: 37090 Kelso RD City/County: Sandy/Clackamas Sampling Date: 3/30/2017
 Applicant/Owner: Joe Spaziani State: OR Sampling Point: P9
 Investigator(s): John McConnaughey, PWS# 2009 Section, Township, Range: T2S R4E S11
 Landform (hillslope, terrace, etc.): Valley Floor Local relief (concave, convex, none): slope Slope (%): 2%
 Subregion (LRR): LRR-A Lat: 45.25023 Long: -122.16985 Datum: _____
 Soil Map Unit Name: Cazado silt loam, Cottrell silty clay loam NWI classification: Not mapped

Are climatic / hydrologic conditions on the site typical for this time of year? Yes No (If no, explain in Remarks.)
 Are Vegetation YES, Soil _____, or Hydrology _____ significantly disturbed? Are "Normal Circumstances" present? Yes No
 Are Vegetation YES, Soil _____, or Hydrology _____ naturally problematic? (If needed, explain any answers in Remarks.)

SUMMARY OF FINDINGS – Attach site map showing sampling point locations, transects, important features, etc.

Hydrophytic Vegetation Present? Yes <input checked="" type="checkbox"/> No <input type="checkbox"/> Hydric Soil Present? Yes <input checked="" type="checkbox"/> No <input type="checkbox"/> Wetland Hydrology Present? Yes <input checked="" type="checkbox"/> No <input type="checkbox"/>	Is the Sampled Area within a Wetland? Yes <input checked="" type="checkbox"/> No <input type="checkbox"/>
Remarks: Above average rainfall in March and April 2017. Mowed down vegetation. This is a fringe plot on the side of upland. The hydrophytic vegetation is problematic invasive and can be argued that they are found in uplands. The observed hydrology between three different days was upland, this plot was taken at 12" but with the amount of rainfall the week of the survey it was higher than normal.	

VEGETATION – Use scientific names of plants.

	Absolute % Cover	Dominant Species?	Indicator Status	
Tree Stratum (Plot size: <u>30'ese</u>)				
1. <u>Pseudotsuga menziesii</u>	<u>5</u>	<u>N</u>	<u>FACU</u>	Dominance Test worksheet: Number of Dominant Species That Are OBL, FACW, or FAC: <u>3</u> (A) Total Number of Dominant Species Across All Strata: <u>4</u> (B) Percent of Dominant Species That Are OBL, FACW, or FAC: <u>75%</u> (A/B)
2. _____	_____	_____	_____	
3. _____	_____	_____	_____	
4. _____	_____	_____	_____	
5. _____	_____	_____	_____	
<u>5</u> = Total Cover				
Sapling/Shrub Stratum (Plot size: <u>30' ese</u>)				
1. <u>Rubus armeniacus</u> (mowed, probably was higher %)	<u>25</u>	<u>Y</u>	<u>FAC</u>	Prevalence Index worksheet: Total % Cover of: _____ Multiply by: _____ OBL species <u>0</u> x 1 = <u>0</u> FACW species <u>0</u> x 2 = <u>0</u> FAC species <u>0</u> x 3 = <u>0</u> FACU species <u>0</u> x 4 = <u>0</u> UPL species <u>0</u> x 5 = <u>0</u> Column Totals: <u>0</u> (A) <u>0</u> (B) Prevalence Index = B/A = <u>0</u>
2. _____	_____	_____	_____	
3. _____	_____	_____	_____	
4. _____	_____	_____	_____	
5. _____	_____	_____	_____	
<u>25</u> = Total Cover				
Herb Stratum (Plot size: <u>30' ese</u>)				
1. _____	_____	_____	_____	Hydrophytic Vegetation Indicators: <input checked="" type="checkbox"/> Dominance Test is >50% <input type="checkbox"/> Prevalence Index is ≤3.0 ¹ <input type="checkbox"/> Morphological Adaptations ¹ (Provide supporting data in Remarks or on a separate sheet) <input type="checkbox"/> Problematic Hydrophytic Vegetation ¹ (Explain) ¹ Indicators of hydric soil and wetland hydrology must be present, unless disturbed or problematic.
2. <u>Anthoxanthum odoratum</u>	<u>20</u>	<u>Y</u>	<u>FACU</u>	
3. <u>Agrostis sp.</u>	<u>30</u>	<u>Y</u>	<u>FAC</u>	
4. <u>Cirsium arvense</u>	<u>15</u>	<u>Y</u>	<u>FAC</u>	
5. _____	_____	_____	_____	
6. _____	_____	_____	_____	
7. _____	_____	_____	_____	
8. _____	_____	_____	_____	
<u>65</u> = Total Cover				
Woody Vine Stratum (Plot size: _____)				
1. _____	_____	_____	_____	Hydrophytic Vegetation Present? Yes <input checked="" type="checkbox"/> No <input type="checkbox"/>
2. _____	_____	_____	_____	
<u>95</u> = Total Cover				
% Bare Ground in Herb Stratum <u>0</u>	% Cover of Biotic Crust <u>0%</u>			
Remarks: _____				

SOIL

Sampling Point: P9 _____

Profile Description: (Describe to the depth needed to document the indicator or confirm the absence of indicators.)								
Depth (inches)	Matrix		Redox Features				Texture	Remarks
	Color (moist)	%	Color (moist)	%	Type ¹	Loc ²		
0-5	7.5YR3/2	100					Silt loam	
5-12	7.5YR3/2	90	5YR4/6	10	C	M	Silty clay loam	
12-18	7.5YR3/2	97	5YR4/6	3	C	M	Silty clay loam	

¹Type: C=Concentration, D=Depletion, RM=Reduced Matrix, CS=Covered or Coated Sand Grains. ²Location: PL=Pore Lining, M=Matrix.

<p>Hydric Soil Indicators: (Applicable to all LRRs, unless otherwise noted.)</p> <input type="checkbox"/> Histosol (A1) <input type="checkbox"/> Sandy Redox (S5) <input type="checkbox"/> Histic Epipedon (A2) <input type="checkbox"/> Stripped Matrix (S6) <input type="checkbox"/> Black Histic (A3) <input type="checkbox"/> Loamy Mucky Mineral (F1) <input type="checkbox"/> Hydrogen Sulfide (A4) <input type="checkbox"/> Loamy Gleyed Matrix (F2) <input type="checkbox"/> Stratified Layers (A5) (LRR C) <input type="checkbox"/> Depleted Matrix (F3) <input type="checkbox"/> 1 cm Muck (A9) (LRR D) <input type="checkbox"/> Redox Dark Surface (F6) <input checked="" type="checkbox"/> Depleted Below Dark Surface (A11) <input type="checkbox"/> Depleted Dark Surface (F7) <input type="checkbox"/> Thick Dark Surface (A12) <input type="checkbox"/> Redox Depressions (F8) <input type="checkbox"/> Sandy Mucky Mineral (S1) <input type="checkbox"/> Sandy Gleyed Matrix (S4)	<p>Indicators for Problematic Hydric Soils³:</p> <input type="checkbox"/> 1 cm Muck (A9) (LRR C) <input type="checkbox"/> 2 cm Muck (A10) (LRR B) <input type="checkbox"/> Reduced Vertic (F18) <input type="checkbox"/> Red Parent Material (TF2) <input type="checkbox"/> Other (Explain in Remarks) <p>³Indicators of hydrophytic vegetation and wetland hydrology must be present, unless disturbed or problematic.</p>
--	--

<p>Restrictive Layer (if present):</p> Type: <u>Clay</u> Depth (inches): <u>12</u>	<p>Hydric Soil Present? Yes <input checked="" type="checkbox"/> No <input type="checkbox"/></p>
--	--

Remarks: _____

HYDROLOGY

<p>Wetland Hydrology Indicators:</p> <p><u>Primary Indicators (minimum of one required; check all that apply)</u></p> <input type="checkbox"/> Surface Water (A1) <input type="checkbox"/> Salt Crust (B11) <input checked="" type="checkbox"/> High Water Table (A2) <input type="checkbox"/> Biotic Crust (B12) <input checked="" type="checkbox"/> Saturation (A3) <input type="checkbox"/> Aquatic Invertebrates (B13) <input type="checkbox"/> Water Marks (B1) (Non riverine) <input type="checkbox"/> Hydrogen Sulfide Odor (C1) <input type="checkbox"/> Sediment Deposits (B2) (Non riverine) <input type="checkbox"/> Oxidized Rhizospheres along Living Roots (C3) <input type="checkbox"/> Drift Deposits (B3) (Non riverine) <input type="checkbox"/> Presence of Reduced Iron (C4) <input type="checkbox"/> Surface Soil Cracks (B6) <input type="checkbox"/> Recent Iron Reduction in Tilled Soils (C6) <input type="checkbox"/> Inundation Visible on Aerial Imagery (B7) <input type="checkbox"/> Thin Muck Surface (C7) <input type="checkbox"/> Water-Stained Leaves (B9) <input type="checkbox"/> Other (Explain in Remarks)				<p><u>Secondary Indicators (2 or more required)</u></p> <input type="checkbox"/> Water Marks (B1) (Riverine) <input type="checkbox"/> Sediment Deposits (B2) (Riverine) <input type="checkbox"/> Drift Deposits (B3) (Riverine) <input type="checkbox"/> Drainage Patterns (B10) <input type="checkbox"/> Dry-Season Water Table (C2) <input type="checkbox"/> Crayfish Burrows (C8) <input type="checkbox"/> Saturation Visible on Aerial Imagery (C9) <input type="checkbox"/> Shallow Aquitard (D3) <input type="checkbox"/> FAC-Neutral Test (D5)			
<p>Field Observations:</p> Surface Water Present? Yes <input type="checkbox"/> No <input checked="" type="checkbox"/> Depth (inches): _____ Water Table Present? Yes <input checked="" type="checkbox"/> No <input type="checkbox"/> Depth (inches): <u>12"</u> Saturation Present? Yes <input checked="" type="checkbox"/> No <input type="checkbox"/> Depth (inches): _____ (includes capillary fringe)				<p>Wetland Hydrology Present? Yes <input checked="" type="checkbox"/> No <input type="checkbox"/></p>			
Describe Recorded Data (stream gauge, monitoring well, aerial photos, previous inspections), if available: 4/17/17 no water, 5/1/17 15" bgs							
Remarks: Due to the other dates observations being below 12" or not there at all and the high waterfall the week of the survey we believe the observed hydrology represents wetter and normal conditions. This is a fringe plot on the side of upland							

WETLAND DETERMINATION DATA FORM – Arid West Region

Project/Site: 37090 Kelso RD City/County: Sandy/Clackamas Sampling Date: 4/15/20
 Applicant/Owner: Joe Spaziani State: OR Sampling Point: P9B
 Investigator(s): John McConnaughey, PWS# 2009 Section, Township, Range: T2S R4E S11
 Landform (hillslope, terrace, etc.): Valley Floor Local relief (concave, convex, none): slope Slope (%): 2%
 Subregion (LRR): LRR-A Lat: 45.25023 Long: -122.16985 Datum: _____
 Soil Map Unit Name: Cazado silt loam, Cottrell silty clay loam NWI classification: Not mapped

Are climatic / hydrologic conditions on the site typical for this time of year? Yes No (If no, explain in Remarks.)
 Are Vegetation YES, Soil _____, or Hydrology _____ significantly disturbed? Are "Normal Circumstances" present? Yes No
 Are Vegetation YES, Soil _____, or Hydrology _____ naturally problematic? (If needed, explain any answers in Remarks.)

SUMMARY OF FINDINGS – Attach site map showing sampling point locations, transects, important features, etc.

Hydrophytic Vegetation Present? Yes <input type="checkbox"/> No <input checked="" type="checkbox"/> Hydric Soil Present? Yes <input type="checkbox"/> No <input checked="" type="checkbox"/> Wetland Hydrology Present? Yes <input type="checkbox"/> No <input checked="" type="checkbox"/>	Is the Sampled Area within a Wetland? Yes <input type="checkbox"/> No <input checked="" type="checkbox"/>
Remarks: <u>15' north of plot 9</u>	

VEGETATION – Use scientific names of plants.

	Absolute % Cover	Dominant Species?	Indicator Status	
Tree Stratum (Plot size: <u>30' ese</u>)				
1. <u>Pseudotsuga menziesii</u>	<u>5</u>	<u>Y</u>	<u>FACU</u>	Dominance Test worksheet: Number of Dominant Species That Are OBL, FACW, or FAC: <u>1</u> (A) Total Number of Dominant Species Across All Strata: <u>2</u> (B) Percent of Dominant Species That Are OBL, FACW, or FAC: <u>50%</u> (A/B)
2. _____	_____	_____	_____	
3. _____	_____	_____	_____	
4. _____	_____	_____	_____	
	<u>5</u>	= Total Cover		
Sapling/Shrub Stratum (Plot size: <u>30' ese</u>)				
1. <u>Rubus armeniacus</u>	<u>100</u>	<u>Y</u>	<u>FAC</u>	Prevalence Index worksheet: Total % Cover of: _____ Multiply by: _____ OBL species <u>0</u> x 1 = <u>0</u> FACW species <u>0</u> x 2 = <u>0</u> FAC species <u>0</u> x 3 = <u>0</u> FACU species <u>0</u> x 4 = <u>0</u> UPL species <u>0</u> x 5 = <u>0</u> Column Totals: <u>0</u> (A) <u>0</u> (B) Prevalence Index = B/A = <u>0</u>
2. _____	_____	_____	_____	
3. _____	_____	_____	_____	
4. _____	_____	_____	_____	
5. _____	_____	_____	_____	
Herb Stratum (Plot size: <u>30' ese</u>)				
1. _____	_____	_____	_____	Hydrophytic Vegetation Indicators: <input type="checkbox"/> Dominance Test is >50% <input type="checkbox"/> Prevalence Index is ≤3.0 ¹ <input type="checkbox"/> Morphological Adaptations ¹ (Provide supporting data in Remarks or on a separate sheet) <input type="checkbox"/> Problematic Hydrophytic Vegetation ¹ (Explain) ¹ Indicators of hydric soil and wetland hydrology must be present, unless disturbed or problematic.
2. _____	_____	_____	_____	
3. _____	_____	_____	_____	
4. _____	_____	_____	_____	
5. _____	_____	_____	_____	
6. _____	_____	_____	_____	
7. _____	_____	_____	_____	
8. _____	_____	_____	_____	
<u>100</u> = Total Cover				
Woody Vine Stratum (Plot size: _____)				
1. _____	_____	_____	_____	Hydrophytic Vegetation Present? Yes <input type="checkbox"/> No <input checked="" type="checkbox"/>
2. _____	_____	_____	_____	
<u>105</u> = Total Cover				
% Bare Ground in Herb Stratum <u>0</u>		% Cover of Biotic Crust <u>0%</u>		
Remarks: _____				

SOIL

Sampling Point: P9B

Profile Description: (Describe to the depth needed to document the indicator or confirm the absence of indicators.)								
Depth (inches)	Matrix		Redox Features				Texture	Remarks
	Color (moist)	%	Color (moist)	%	Type ¹	Loc ²		
0-9	10YR3/2	70					Silt loam	Mixed matrix
	7.5YR4/6	30						
9-11	7.5YR4/6	96	10YR3/2	4	C	M	Clay layer	
11-16	10YR3/2	50						Mixed matrix
	7.5YR4/6	50						

¹Type: C=Concentration, D=Depletion, RM=Reduced Matrix, CS=Covered or Coated Sand Grains. ²Location: PL=Pore Lining, M=Matrix.

Hydric Soil Indicators: (Applicable to all LRRs, unless otherwise noted.) <input type="checkbox"/> Histosol (A1) <input type="checkbox"/> Histic Epipedon (A2) <input type="checkbox"/> Black Histic (A3) <input type="checkbox"/> Hydrogen Sulfide (A4) <input type="checkbox"/> Stratified Layers (A5) (LRR C) <input type="checkbox"/> 1 cm Muck (A9) (LRR D) <input type="checkbox"/> Depleted Below Dark Surface (A11) <input type="checkbox"/> Thick Dark Surface (A12) <input type="checkbox"/> Sandy Mucky Mineral (S1) <input type="checkbox"/> Sandy Gleyed Matrix (S4)	<input type="checkbox"/> Sandy Redox (S5) <input type="checkbox"/> Stripped Matrix (S6) <input type="checkbox"/> Loamy Mucky Mineral (F1) <input type="checkbox"/> Loamy Gleyed Matrix (F2) <input type="checkbox"/> Depleted Matrix (F3) <input type="checkbox"/> Redox Dark Surface (F6) <input type="checkbox"/> Depleted Dark Surface (F7) <input type="checkbox"/> Redox Depressions (F8)	Indicators for Problematic Hydric Soils³: <input type="checkbox"/> 1 cm Muck (A9) (LRR C) <input type="checkbox"/> 2 cm Muck (A10) (LRR B) <input type="checkbox"/> Reduced Vertic (F18) <input type="checkbox"/> Red Parent Material (TF2) <input type="checkbox"/> Other (Explain in Remarks)
--	---	--

³Indicators of hydrophytic vegetation and wetland hydrology must be present, unless disturbed or problematic.

Restrictive Layer (if present): Type: <u>Clay</u> Depth (inches): <u>12</u>	Hydric Soil Present? Yes <input type="checkbox"/> No <input checked="" type="checkbox"/>
--	---

Remarks: Soil appeared to be a mixed matrix through out except when i got to the clay layer which was a 2" solid reddish color. We speculate this unusual soil is a result of soils sloughing down from upslope, and many years of cultivation when the area was farmed.

HYDROLOGY

Wetland Hydrology Indicators: <u>Primary Indicators (minimum of one required; check all that apply)</u>			<u>Secondary Indicators (2 or more required)</u>		
<input type="checkbox"/> Surface Water (A1) <input type="checkbox"/> High Water Table (A2) <input type="checkbox"/> Saturation (A3) <input type="checkbox"/> Water Marks (B1) (Non riverine) <input type="checkbox"/> Sediment Deposits (B2) (Non riverine) <input type="checkbox"/> Drift Deposits (B3) (Non riverine) <input type="checkbox"/> Surface Soil Cracks (B6) <input type="checkbox"/> Inundation Visible on Aerial Imagery (B7) <input type="checkbox"/> Water-Stained Leaves (B9)	<input type="checkbox"/> Salt Crust (B11) <input type="checkbox"/> Biotic Crust (B12) <input type="checkbox"/> Aquatic Invertebrates (B13) <input type="checkbox"/> Hydrogen Sulfide Odor (C1) <input type="checkbox"/> Oxidized Rhizospheres along Living Roots (C3) <input type="checkbox"/> Presence of Reduced Iron (C4) <input type="checkbox"/> Recent Iron Reduction in Tilled Soils (C6) <input type="checkbox"/> Thin Muck Surface (C7) <input type="checkbox"/> Other (Explain in Remarks)	<input type="checkbox"/> Water Marks (B1) (Riverine) <input type="checkbox"/> Sediment Deposits (B2) (Riverine) <input type="checkbox"/> Drift Deposits (B3) (Riverine) <input type="checkbox"/> Drainage Patterns (B10) <input type="checkbox"/> Dry-Season Water Table (C2) <input type="checkbox"/> Crayfish Burrows (C8) <input type="checkbox"/> Saturation Visible on Aerial Imagery (C9) <input type="checkbox"/> Shallow Aquitard (D3) <input type="checkbox"/> FAC-Neutral Test (D5)			
Field Observations: Surface Water Present? Yes <input type="checkbox"/> No <input checked="" type="checkbox"/> Depth (inches): _____ Water Table Present? Yes <input type="checkbox"/> No <input checked="" type="checkbox"/> Depth (inches): > 16" _____ Saturation Present? Yes <input type="checkbox"/> No <input checked="" type="checkbox"/> Depth (inches): _____ (includes capillary fringe)			Wetland Hydrology Present? Yes <input type="checkbox"/> No <input checked="" type="checkbox"/>		
Describe Recorded Data (stream gauge, monitoring well, aerial photos, previous inspections), if available:					
Remarks:					

WETLAND DETERMINATION DATA FORM – Arid West Region

Project/Site: 37090 Kelso RD City/County: Sandy/Clackamas Sampling Date: 3/30/2017
 Applicant/Owner: Joe Spaziani State: OR Sampling Point: P10
 Investigator(s): John McConnaughey, PWS# 2009 Section, Township, Range: T2S R4E S11
 Landform (hillslope, terrace, etc.): Valley Floor Local relief (concave, convex, none): slope Slope (%): 3%
 Subregion (LRR): LRR-A Lat: 45.41777 Long: -122.28298 Datum: _____
 Soil Map Unit Name: Cazado silt loam, Cottrell silty clay loam NWI classification: Not mapped

Are climatic / hydrologic conditions on the site typical for this time of year? Yes No (If no, explain in Remarks.)

Are Vegetation _____, Soil _____, or Hydrology _____ significantly disturbed? Are "Normal Circumstances" present? Yes No

Are Vegetation _____, Soil _____, or Hydrology _____ naturally problematic? (If needed, explain any answers in Remarks.)

SUMMARY OF FINDINGS – Attach site map showing sampling point locations, transects, important features, etc.

Hydrophytic Vegetation Present? Yes <input checked="" type="checkbox"/> No <input type="checkbox"/> Hydric Soil Present? Yes <input type="checkbox"/> No <input checked="" type="checkbox"/> Wetland Hydrology Present? Yes <input checked="" type="checkbox"/> No <input type="checkbox"/>	Is the Sampled Area within a Wetland? Yes <input checked="" type="checkbox"/> No <input type="checkbox"/>
Remarks: Above average rainfall in March and April.	

VEGETATION – Use scientific names of plants.

	Absolute % Cover	Dominant Species?	Indicator Status		
Tree Stratum (Plot size: <u>5' cir</u>)					
1. _____	_____	_____	_____	Dominance Test worksheet: Number of Dominant Species That Are OBL, FACW, or FAC: <u>3</u> (A) Total Number of Dominant Species Across All Strata: <u>3</u> (B) Percent of Dominant Species That Are OBL, FACW, or FAC: <u>100%</u> (A/B)	
2. _____	_____	_____	_____		
3. _____	_____	_____	_____		
4. _____	_____	_____	_____		
_____ = Total Cover				Prevalence Index worksheet: Total % Cover of: _____ Multiply by: _____ OBL species <u>0</u> x 1 = <u>0</u> FACW species <u>0</u> x 2 = <u>0</u> FAC species <u>0</u> x 3 = <u>0</u> FACU species <u>0</u> x 4 = <u>0</u> UPL species <u>0</u> x 5 = <u>0</u> Column Totals: <u>0</u> (A) <u>0</u> (B) Prevalence Index = B/A = <u>0</u>	
Sapling/Shrub Stratum (Plot size: <u>5' cir</u>)					
1. <u>Rubus armeniacus</u>	<u>40</u>	<u>Y</u>	<u>FAC</u>		
2. _____	_____	_____	_____		
3. _____	_____	_____	_____		
4. _____	_____	_____	_____		
5. _____	_____	_____	_____		
_____ = Total Cover				Hydrophytic Vegetation Indicators: <input checked="" type="checkbox"/> Dominance Test is >50% <input type="checkbox"/> Prevalence Index is ≤3.0 ¹ <input type="checkbox"/> Morphological Adaptations ¹ (Provide supporting data in Remarks or on a separate sheet) <input type="checkbox"/> Problematic Hydrophytic Vegetation ¹ (Explain) ¹ Indicators of hydric soil and wetland hydrology must be present, unless disturbed or problematic.	
Herb Stratum (Plot size: <u>30' ese</u>)					
1. <u>Poa sp.</u>	<u>40</u>	<u>Y</u>	<u>FAC</u>		
2. <u>moss</u>	<u>80</u>	<u>Y</u>	<u>NA</u>		
3. <u>Agrostis sp.</u>	<u>20</u>	<u>Y</u>	<u>FAC</u>		
4. <u>Cirsium arvense</u>	<u>10</u>	<u>N</u>	<u>FAC</u>		
5. <u>Herb 1</u>	<u>10</u>	<u>N</u>	<u>NA</u>		
6. _____	_____	_____	_____		
7. _____	_____	_____	_____		
8. _____	_____	_____	_____		
_____ = Total Cover				Hydrophytic Vegetation Present? Yes <input checked="" type="checkbox"/> No <input type="checkbox"/>	
Woody Vine Stratum (Plot size: _____)					
1. _____	_____	_____	_____		
2. _____	_____	_____	_____		
_____ = Total Cover					
% Bare Ground in Herb Stratum <u>0</u>		% Cover of Biotic Crust <u>0%</u>			
Remarks:					

SOIL

Sampling Point: P10 _____

Profile Description: (Describe to the depth needed to document the indicator or confirm the absence of indicators.)

Depth (inches)	Matrix		Redox Features				Texture	Remarks
	Color (moist)	%	Color (moist)	%	Type ¹	Loc ²		
0-6	7.5YR3/3	100					Silt loam	
6-13	7.5YR3/2	100					Silty clay loam	
13-18	7.5YR3/4	100					Silty clay loam	

¹Type: C=Concentration, D=Depletion, RM=Reduced Matrix, CS=Covered or Coated Sand Grains. ²Location: PL=Pore Lining, M=Matrix.

Hydric Soil Indicators: (Applicable to all LRRs, unless otherwise noted.)

<input type="checkbox"/> Histosol (A1)	<input type="checkbox"/> Sandy Redox (S5)	Indicators for Problematic Hydric Soils³: <input type="checkbox"/> 1 cm Muck (A9) (LRR C) <input type="checkbox"/> 2 cm Muck (A10) (LRR B) <input type="checkbox"/> Reduced Vertic (F18) <input checked="" type="checkbox"/> Red Parent Material (TF2) <input type="checkbox"/> Other (Explain in Remarks) ³ Indicators of hydrophytic vegetation and wetland hydrology must be present, unless disturbed or problematic.
<input type="checkbox"/> Histic Epipedon (A2)	<input type="checkbox"/> Stripped Matrix (S6)	
<input type="checkbox"/> Black Histic (A3)	<input type="checkbox"/> Loamy Mucky Mineral (F1)	
<input type="checkbox"/> Hydrogen Sulfide (A4)	<input type="checkbox"/> Loamy Gleyed Matrix (F2)	
<input type="checkbox"/> Stratified Layers (A5) (LRR C)	<input type="checkbox"/> Depleted Matrix (F3)	
<input type="checkbox"/> 1 cm Muck (A9) (LRR D)	<input type="checkbox"/> Redox Dark Surface (F6)	
<input type="checkbox"/> Depleted Below Dark Surface (A11)	<input type="checkbox"/> Depleted Dark Surface (F7)	
<input type="checkbox"/> Thick Dark Surface (A12)	<input type="checkbox"/> Redox Depressions (F8)	
<input type="checkbox"/> Sandy Mucky Mineral (S1)		
<input type="checkbox"/> Sandy Gleyed Matrix (S4)		

Restrictive Layer (if present):
 Type: Clay
 Depth (inches): 13

Hydric Soil Present? Yes No

Remarks:

HYDROLOGY

Wetland Hydrology Indicators:

<u>Primary Indicators (minimum of one required; check all that apply)</u>		<u>Secondary Indicators (2 or more required)</u>
<input type="checkbox"/> Surface Water (A1)	<input type="checkbox"/> Salt Crust (B11)	<input type="checkbox"/> Water Marks (B1) (Riverine)
<input checked="" type="checkbox"/> High Water Table (A2)	<input type="checkbox"/> Biotic Crust (B12)	<input type="checkbox"/> Sediment Deposits (B2) (Riverine)
<input checked="" type="checkbox"/> Saturation (A3)	<input type="checkbox"/> Aquatic Invertebrates (B13)	<input type="checkbox"/> Drift Deposits (B3) (Riverine)
<input type="checkbox"/> Water Marks (B1) (Non riverine)	<input type="checkbox"/> Hydrogen Sulfide Odor (C1)	<input type="checkbox"/> Drainage Patterns (B10)
<input type="checkbox"/> Sediment Deposits (B2) (Non riverine)	<input type="checkbox"/> Oxidized Rhizospheres along Living Roots (C3)	<input type="checkbox"/> Dry-Season Water Table (C2)
<input type="checkbox"/> Drift Deposits (B3) (Non riverine)	<input type="checkbox"/> Presence of Reduced Iron (C4)	<input type="checkbox"/> Crayfish Burrows (C8)
<input type="checkbox"/> Surface Soil Cracks (B6)	<input type="checkbox"/> Recent Iron Reduction in Tilled Soils (C6)	<input type="checkbox"/> Saturation Visible on Aerial Imagery (C9)
<input type="checkbox"/> Inundation Visible on Aerial Imagery (B7)	<input type="checkbox"/> Thin Muck Surface (C7)	<input type="checkbox"/> Shallow Aquitard (D3)
<input type="checkbox"/> Water-Stained Leaves (B9)	<input type="checkbox"/> Other (Explain in Remarks)	<input type="checkbox"/> FAC-Neutral Test (D5)

Field Observations:

Surface Water Present?	Yes <input type="checkbox"/> No <input checked="" type="checkbox"/>	Depth (inches): _____	Wetland Hydrology Present? Yes <input checked="" type="checkbox"/> No <input type="checkbox"/>
Water Table Present?	Yes <input checked="" type="checkbox"/> No <input type="checkbox"/>	Depth (inches): <u>8"</u>	
Saturation Present? (includes capillary fringe)	Yes <input checked="" type="checkbox"/> No <input type="checkbox"/>	Depth (inches): <u>8"</u>	

Describe Recorded Data (stream gauge, monitoring well, aerial photos, previous inspections), if available: 4/17/17 no water, 5/1/17 11" bgs

Remarks:

APPENDIX C - Ground Level Color Photographs:

Photos of Wetland "A" are from the 2017 wetland delineation and new photos from the 2020 delineation.



Photo 1. Wetland "A" data plots P1 Upland (left), and P2 Wetland (right). The blackberries had been recently mowed to give surveyors access. The wetland determination was based on soils and hydrology. ETC Photo 4/28/2017.



Photo 2. Lower portion of Wetland "A" showing excessive algal growth due to fertilizers washed down from farms and nurseries upslope. ETC Photo 4/28/2017



Photo 3. New P5B upland plot, photo looking into upland to the southeast. ETC Photo 4/15/2020



Photo 4: Looking the south at P5B into Wetland "A". ETC Photo 4/15/2020

APPENDIX D - Sensitive Area Certification:

Fish Presence:

No fish are thought to be present on the subject property, nor would they be expected.

Endangered Species:

No endangered species of plants or animals were observed or reported.

Critical Habitat Features:

The property was surveyed for the following critical habitat features. Not all of these features are considered rare or critical by the City Sandy:

- Talus slopes – none
- Caves, cliffs, crevasses, rock outcrops – none
- Large oak trees, or oak groves or oak savanna – none
- Snags – none
- Large woody debris – none
- Springs, seeps - None.
- Deep water habitat – None
- Vernal pool wetlands – None
- Old growth forest – None.
- Wetlands – Described above.
- Fish spawning or rearing habitat – none. It is believed that there is no fish access to this property.